



USDOT Region V Regional University Transportation Center Final Report

NEXTRANS Project No. 046IY02

Determining Queue and Congestion in Highway Work Zone Bottlenecks

By

Hani Ramezani
Graduate Research Assistant
Civil and Environmental Engineering
University of Illinois, Urbana-Champaign
hrameza2@illinois.edu

Rahim F. Benekohal
Professor of Civil and Environmental Engineering
University of Illinois, Urbana-Champaign
rbenekoh@uiuc.edu

Kıvanç A. Avrenli
Graduate Research Assistant
Civil and Environmental Engineering
University of Illinois, Urbana-Champaign
avrenli2@illinois.edu

DISCLAIMER

Funding for this research was provided by the NEXTRANS Center, Purdue University under Grant No. DTRT07-G-005 of the U.S. Department of Transportation, Research and Innovative Technology Administration (RITA), University Transportation Centers Program. The contents of this report reflect the views of the authors, who are responsible for the facts and the accuracy of the information presented herein. This document is disseminated under the sponsorship of the Department of Transportation, University Transportation Centers Program, in the interest of information exchange. The U.S. Government assumes no liability for the contents or use thereof.



USDOT Region V Regional University Transportation Center Final Report

TECHNICAL SUMMARY

NEXTRANS Project No. 046IY02

Final Report, Date, March 11, 2011

Determining Queue and Congestion in Highway Work Zone Bottlenecks

Introduction

Construction zones, though required for infrastructure maintenance, have become congestion choke points on most highway systems in the US. The congestion may create potentially unsafe driving conditions for approaching motorists that do not expect queue there. Managing the growth and dissipation of vehicular queue upstream and within work zones can help reduce congestion and improve traffic safety. However, critical issues are how to determine the extent of queue and congestion accurately, as well as how to best use that information in managing the adverse effects of queue.

This study investigated some of the issues in capacity, queue length, and delay estimation in work zones. In particular, the current methods for analyzing congestion in work zones are examined. Further requirements to improve the accuracy of analysis are identified and discussed. The effect of large gaps between vehicles on capacity measurement is determined using field data. Alternative methods for computing work zone capacity were developed. Furthermore, two types of moving queue are studied: 1) intermittent moving queue, 2) continuous moving queue. The characteristics of each type of queue are studied using field data. A methodology to estimate intermittent queue length and delay is proposed. The study investigates continuous moving queue propagation and dissipation using shockwave theory. Also, formulations are developed to estimate continuous moving queue length and delay.

Findings

Software programs for analyzing queuing and delay in work zones were examined. Two types of software programs were considered: 1) Analytical software programs 2) Micro-simulation software programs. Analytical software programs do not directly model some of the field conditions such as moving queue, presence of flagger and ITS. On the other hand, micro-simulation software programs need more input data and human resources compared to analytical software programs. Although micro-simulation packages apply some behavioral rules to simulate drivers' reactions and vehicles motion, the behavior of drivers in work zones is not well known. The effects of large gaps on capacity measurement were investigated. Usually, maximum 15-minute flow rate is used to measure capacity. Data analysis showed that pre-breakdown and post-break down capacity values may be underestimated due to the presence of large gaps in the traffic stream. On the other hand, presence of large gaps does not have substantial effect on measuring breakdown capacity.

Furthermore, two types of moving queue were studied: 1) intermittent moving queue, 2) continuous moving queue. A methodology to estimate intermittent queue length and delay was developed that can estimate delay and queue length when the congestion last for a portion of the analysis period or longer. The methodology is capable of estimating queue length and delay

under both uniform and non-uniform arrival pattern. Continuous moving queue propagation and dissipation were investigated using shockwave theory. The following three locations were considered as the potential bottlenecks in work zones: 1) the work space, 2) the beginning of the transition area, 3) both locations. The interactions among the shockwaves caused by the bottleneck locations were investigated. Formulations were developed to estimate continuous moving queue length and the resulting delay for each case.

Recommendations

The following recommendations are made:

- Further studies are needed to determine the appropriateness and accuracy of using software programs that are developed for stopped queue conditions in analyzing moving queue conditions.
- Developing a software program capable of analyzing intermittent and continuous moving queues in work zones.
- Data collection and capacity measurement for varying work zone conditions (like presence of ITS and different geometric configurations) that are not covered in the existing analytical software programs.
- Collection of further field data is recommended to explore whether post-break down and pre-break down capacities are practically different for a given site.

Contacts

For more information:

Rahim F. Benekohal

Principal Investigator

Civil and Environmental Engineering

University of Illinois, Urbana-Champaign

rbenekoh@uiuc.edu

NEXTRANS Center

Purdue University - Discovery Park

2700 Kent B-100

West Lafayette, IN 47906

nextrans@purdue.edu

(765) 496-9729

(765) 807-3123 Fax

www.purdue.edu/dp/nextrans

TABLE OF CONTENTS

	Page
LIST OF FIGURES	iv
CHAPTER 1. INTRODUCTION	1
CHAPTER 2. SOFTWARE FOR ESTIMATING QUEUE LENGTH AND DELAY IN WORK ZONE3	
2.1 Analytical models	3
2.1.1 Introduction.....	3
2.1.2 Input data for analytical software programs	4
2.1.3 Algorithms	6
2.1.4 Output data for analytical software programs.....	10
2.2 Micro-simulation software programs	12
2.2.1 FRESIM	12
2.2.2 Shortcomings of simulation software programs	14
2.3 Some other software programs	14
2.3.1 ODOT spreadsheet.....	14
2.3.2 CA4PRS.....	15
2.4 Comparison of the work zone software programs in the literature	16
2.5 Summary.....	21
2.6 References.....	23
CHAPTER 3. CAPACITY ESTIMATION	25

3.1	Introduction.....	25
3.2	Field data	25
3.3	Methodology.....	27
3.4	Findings	29
3.5	Discussion.....	31
3.6	Reference	33
CHAPTER 4. INTERMITTENT QUEUE		34
4.1	Problem Statement.....	35
4.2	Methodology.....	36
4.2.1	Group characteristics	38
4.2.2	Queue length and delay for a cycle.....	39
4.2.3	Total delay during the analysis interval	42
4.3	Discussion.....	46
4.3.1	Queue length variation	46
4.3.2	Input variables.....	47
4.4	Reference	48
CHAPTER 5. QUEUE FORMATION AND DISSIPATION IN WORK ZONES		49
5.1	Introduction.....	49
5.2	Geometry of a typical 2-1 work zone	50
5.3	Notation	52
5.4	Queue Formation	52
5.4.1	Case 2: Arriving volume is less than the capacity of the transition area but greater than the work space capacity	54
5.4.2	Case3: Arriving volume is greater than the capacities of the transition area and the work space.....	56
5.5	Queue dissipation.....	60
5.6	Delay and queue length computation	61
5.6.1	Length of a traffic state	62
5.6.2	Delay.....	63

5.6.3	Summary	67
5.7	Conclusions and discussions.....	69
5.8	References.....	70
CHAPTER 6. CONCLUSIONS		71

LIST OF FIGURES

Figure	Page
Figure 3-1: Two- minute Speed and Flow Data for I-55SB	26
Figure 3-2: Two- minute Speed and Flow Data for I-74EB	27
Figure 3-3: Platoon Ratio Versus Observed Flow Rate for a) Pre-break Down and b) Post-break Down Conditions	29
Figure 3-4: Platoon Ratio Versus Observed Flow Rate for Break Down Condition at a) I- 55SB and b) I-74EB	30
Figure 4-1: Moving Queue Types: a) Continuous Moving Queue, and b) Intermittent Moving Queue	35
Figure 4-2: Cumulative Arrival for Vehicles Moving in Separate Groups	37
Figure 4-3: Number of Vehicles in the Intermittent Queue for Different Cycles.....	40
Figure 4-4: Average Number of Vehicles in the Queue for Each T_i	45
Figure 5-1: The Typical Sketch of 2-to-1 Work Zones	51
Figure 5-2: Simplified Sketch of a 2-to-1 Work Zone.....	52
Figure 5-3: The Flow-density Curves of The Three Work Zone sections	54
Figure 5-4: Traffic Evolution in The Work Zone for Case2.1	56
Figure 5-5: Traffic Evolution in The Work Zone for Case3.1	58
Figure 5-6: Traffic Evolution in The Work Zone for Case 3.2.....	59
Figure 5-7: Queue Dissipation in The Work Zone	61
Figure 5-8: Category One	64
Figure 5-9: Category Two.....	66
Figure 5-10: Category Three.....	67
Figure 5-11: Category Four	67

CHAPTER 1. INTRODUCTION

Construction zones, though necessary activities for infrastructure maintenance, have become congestion choke points on most highway system in the US. Various mitigation measures such as working on off-peak hours or nighttime, rerouting traffic, offering incentive for early completion, using ITS technologies, etc have been used to reduce the effects of work zone congestion; however, long queues and heavy congestion are still common in busy highway work zones. In work zones with high traffic volume, the effects of vehicular queue on congestion are more pronounced due to interaction among adjacent drivers and between drivers and roadway or traffic control devices. Often congestion grows to upstream of the work zones and creates slow moving or stopped queues on the normal sections of the highways. Then, the queues become the congestion choke points and could create potentially unsafe driving conditions for approaching drivers that do not expect to encounter queue there. Managing the growth and dissipation of vehicular queue within and in advance of work zones could help to reduce congestion and improve traffic safety. However, the critical issue is how to determine the extent of queue and congestion accurately, as well as how best to use that information in managing the adverse effects of the queue.

The objective of this study is to address and solve some of the issues in capacity, queue length, and delay estimation for work zones. In particular, the current methods to analyze congestion in work zones are examined. Further requirements to improve analysis are identified and some of them are discussed and solved in this study.

The report includes 6 chapters. Chapter 1 introduces and presents the objectives of the study. Chapter 2 examines software programs, used to analyze congestion in work zones. The techniques that each software program applies to estimate capacity, queue

length and delay will be looked. Also some of the related software evaluations, available in the literature are reviewed.

Chapter 3 investigates the effects of large gaps between vehicles on capacity measurement. The maximum 15-minute flow rate is used to measure the capacity for these conditions: pre-break down, breakdown and post-break down. This method of capacity measurement is based on the definition of capacity in HCM 2000. It is shown how the presence of large gaps will adversely affect the measurements for the above-mentioned conditions. Then the alternative methods of capacity measurement that are less affected by large gaps are discussed.

Chapter 4 and 5 discuss moving queues. Two types of moving queue are considered in this report: intermittent moving queue and continuous moving queue. Chapter 4 develops a methodology to estimate intermittent queue length and delay. The methodology is capable of estimating queue length and delay under both uniform and non-uniform arrival pattern. Chapter 5 uses shockwave theory to explain how continuous moving queues form and dissipate in work zones. Bottlenecks due to work zones can potentially develop in three different cases: at the work space, at the beginning of the transition area and at both locations. The traffic conditions that cause each of the three cases were discussed. Formulations were developed to estimate continuous moving queue length and the resulting delay for each case. Conclusions and recommendations are made in Chapter 6.

CHAPTER 2. SOFTWARE FOR ESTIMATING QUEUE LENGTH AND DELAY IN WORK ZONE

There are two types of software programs to estimate queue length and delay in work zones: analytical software programs and micro-simulation software programs. The results from delay and queue length estimations are used in deciding hours of construction (peak, off peak, day time, nighttime), selecting traffic management strategies, or in providing real-time information to motorists. Hence it is important to know how reasonable the results are compared to real world work zone conditions. Analytical software programs utilize an equation or a series of equations to estimate work zone capacity, queue length and delay. On the other hand, micro-simulation software programs model the movement of individual vehicles based on particular car-following and lane-changing algorithms. The following sections provide detailed explanation on the analytical and micro-simulation models as well as some relevant software evaluation studies in the literature.

2.1 *Analytical models*

2.1.1 **Introduction**

Two of the most popular analytical software programs for computing road user costs in work zones are QUEWZ and QuickZone. QUEWZ was developed by the Texas Transportation Institute in the late 1990s as part of a study: “Air Quality Impacts of Highway Construction and Scheduling.” The most recent version of QUEWZ is QUEWZ-98, which is a menu driven program that can be run with DOS. By using QUEWZ, additional road user costs induced by lane closure and a construction project can be computed. The road user costs include travel time costs, vehicle operating costs and emission costs. The QUEWZ model can be applied to work zones on multilane divided highways or freeways up to six lanes per direction (Benekohal, Kaja-Mohideen, and Chitturi, 2003).

QuickZone was developed by the Federal Highway Administration (FHWA) after it was recommended by an FHWA report in 1998 to develop an analytical tool for estimating work zone delays. QuickZone is written as a small program within Microsoft Excel. QuickZone can compute queues, delay and costs due to work zones, estimate delay as a consequence of alternative project phasing plans. It can also analyze the tradeoff between delay costs and construction costs (Benekohal, Kaja-Mohideen, and Chitturi, 2003).

Another analytical software program is INTELLIZONE that was developed by Jiang and Adeli (2004). The software program was developed as an object-oriented model using Visual C++ and the Microsoft Foundation Class library. INTELLIZONE considers 17 factors in estimating work zone capacity. The capacity estimation model is based on data from previous studies from various work zone configurations and different traffic/geometry conditions. A work zone capacity depends on a few key factors that are prevalent at that site. Aggregating data from various work zones may not yield meaningful work zone capacity estimation.

WZCAT (Work Zone Capacity Analysis Tool) is a recently developed analytical software program to estimate queue length and delay for short-term (i.e. daily) work zones. It was developed by Wisconsin Department of Transportation based on the principles of the Delay Enhanced software program in the late 1990s. The concept of the program was founded on a deterministic queuing analysis. Similar to QuickZone, WZCAT also operates within Microsoft Excel. WZCAT-R is the most recent version of WZCAT (Lee, Noyce, and Qin, 2008).

2.1.2 Input data for analytical software programs

2.1.2.1 QUEWZ

The input data required by QUEWZ are classified into four categories (Benekohal, Kaja-Mohideen, and Chitturi, 2003):

- Lane closure configuration: Number of open and closed lanes through the work zone in each direction, length of lane closure, work zone capacity.

- Schedule of work activity: The beginning and end hours of lane closure as well as the beginning and end hours of work activity.
- Traffic volumes: Directional hourly volumes or AADT of the roadway, the day of the week, freeway location (i.e. whether urban or rural).
- Alternative values to the default model constants: Cost update factor, percentage of trucks, speed-volume relationship, work zone capacity, pollutant emissions rank, definition of excessive queuing.

2.1.2.2 QuickZone

There are four different categories of input data that QuickZone requires (Benekohal, Kaja-Mohideen, and Chitturi, 2003):

- Network: Network description with nodes, links, their attributes, and the identification of the mainline and detour links. Multiple work zones in a corridor can be analyzed with QuickZone (Hardy et al, 2007).
- Project information: Project start date and duration.
- Construction phase data: Infrastructure cost and duration.
- Work zone plan: Start and end date of each plan, day(s) and time of the week, capacity reduction of each link affected by the construction, mitigation strategy.

2.1.2.3 INTELLIZONE

There are mainly two types of input data required to run INTELLIZONE (Jiang and Adeli, 2004):

- Input data for estimating work zone capacity: These data are used in the neural network model of INTELLIZONE and include percentage of trucks, pavement grade, number of lanes, number of closed lanes, lane width, work zone layout, work intensity, length of closed lanes, work zone speed, proximity of ramps, work zone location, work duration, work day, work time, weather condition, pavement condition, and driver composition.
- Input data for estimating queue length and delay: Once work zone capacity is estimated, these data are used to estimate queue length and delay due to the work

zone. It includes hourly traffic volume, seasonal demand factor, diversion factor and freeway capacity.

2.1.2.4 WZCAT

The following input data are required to run WZCAT (Hardy and Wunderlich, 2009):

- Work zone capacity (this can also be estimated by WZCAT with respect to the relevant HCM 2000 methodology),
- Traffic volume estimated from a single detector upstream of the work zone,
- Demand adjustment factor (for WZCAT-R),
- Volume entering and exiting from all on- and off-ramps within reasonable distance (for WZCAT-R).

2.1.3 Algorithms

In this section the analytical techniques, used to estimate capacity, queue length and delay are discussed for these programs: QUEWZ, QuickZone, *INTELLIZONE*, and *WZCAT*.

2.1.3.1 QUEWZ

In QUEWZ, the capacity of a work zone with work activity is estimated by the 1994 HCM model for short-term work zone capacity. The model considers the effects of work intensity and entrance ramps on work zone capacity. Once the volume and capacity is known, QUEWZ computes hourly v/c ratios under normal and lane closure conditions. Then QUEWZ estimates the average speed of the vehicles for each hour from the v/c ratios by using a predefined speed-volume relationship. The assumed speed-volume relationship is linear for v/c ratios less than or equal to the v/c ratio at the LOS D/E breakpoint. On the other hand, it is assumed to be quadratic for v/c ratios greater than the v/c ratio at the LOS D/E breakpoint and less than or equal to 1.0 (Benekohal, Kaja-Mohideen, and Chitturi, 2003).

Next, QUEWZ computes the travel time costs based on the delay due to travelling at a lower speed through the work zone. If demand is greater than capacity, QUEWZ also computes queuing delay and queue lengths based on the input-output analysis technique described in Chapter 6 of the HCM 1994 (Benekohal, Kaja-Mohideen, and Chitturi, 2003). In addition to travel time costs, QUEWZ also computes vehicle operating costs due to speed change cycles and changes in vehicle running costs based on Memmott (1991).

Moreover, QUEWZ-98 offers the option of using the Diversion Algorithm for the estimation of road user costs. In urban freeway work zones, some traffic might divert from the freeway as queue lengths and delays increase and reach a threshold level. The Diversion Algorithm estimates the traffic volume that diverts from the freeway so that the estimated delay and queue lengths do not exceed a certain threshold. It should be noted that it is not recommended to use the Diversion Algorithm for rural areas. For urban areas, it is recommended to be used when there is opportunity for drivers to divert from the freeway lane closure such as in the presence of parallel frontage roads (Benekohal, Kaja-Mohideen, and Chitturi, 2003).

2.1.3.2 QuickZone

A QuickZone model involves a mainline, which is a system of several consecutive links with some of them having lane closure. Unlike QUEWZ, QuickZone does not estimate work zone capacity. Instead, users can either input the reduction in capacity or compute it for each link from the work zone capacity models of HCM 1997 or HCM 2000 (Chitturi and Benekohal, 2003). The most recent version of this software is called Quickzone2.

Capacity is either an input value by the user or estimated by one of the three models available in the software. The user can choose the HCM 1997 model, the HCM 2000 model, or the model proposed by the University of Maryland (UMD model).

QuickZone employs the input-output analysis. The procedure requires the capacity and demand volume for each link. For the first link of the mainline, the demand

volume for a given hour equals the input demand for that hour plus the number of vehicles in queue from the previous hour. For the other links of the mainline, the demand volume for a given hour equals the number of vehicles in queue from the previous hour plus the total inflow for that hour from the upstream mainline link and from other upstream links that are not on the mainline. QuickZone2 calculates the queue lengths for the conditions with and without lane closures. The number of vehicles in the queue is determined by inflow-outflow analysis. Similar to QUEWZ, delay and queue length are computed assuming that vehicles are stopped in the queue. Therefore, it is not recommended to use these software programs for work zone with moving queues (Benekohal, Kaja-Mohideen, and Chitturi, 2003).

While computing the queue lengths, QuickZone also considers three factors that may lead to reduction in the demand of the first link of the mainline due to:

- i) Drivers that change their departure time to avoid congestion,
- ii) Detouring vehicles,
- iii) Drivers that cancel their trip or use another mode when the queue length exceeds more than normal condition.

It is assumed that the number of vehicles that would change departure time is equal to a fraction of the additional queued vehicles in the case of lane closure compared to the case of no lane closure. The user can specify that fraction. The number of detouring vehicles depends on the minimum spare capacity available on detour routes, queue length, and presence of traveler information systems. Besides, the fraction of the vehicles that would cancel mainline trip or use another mode is specified by the user (Benekohal, Kaja-Mohideen, and Chitturi, 2003).

One limitation of QuickZone (including Quickzone2) is that the delay due to slower speed of vehicles is not considered in its algorithm. Hence, QuickZone returns no delay when there are undersaturated conditions; i.e. the demand is less than capacity. (Chitturi and Benekohal, 2003).

2.1.3.3 INTELLIZONE

Because estimation of work zone capacity heavily influences the accuracy of queue and delay estimations, Jiang and Adeli (2004) used a radial-basis function neural network in INTELLIZONE to more accurately estimate work zone capacity. The architecture of the radial-basis function neural network has an input layer with 17 nodes, each representing an input variable for estimating work zone capacity. There is a hidden layer with radial-basis transfer functions, and an output layer with one node for the work zone capacity. Some of the 17 input variables are categorical variables, so they are converted into numerical values normalized between 0.0 and 1.0. The numerical variables are also normalized between 0.0 and 1.0 so that there is no variable(s) dominating the training process. Further details regarding the capacity estimation algorithm are given by Karim and Adeli (2003).

In order to estimate queue length and delay, INTELLIZONE uses a deterministic macroscopic queuing model. The model is established based on the conservation of flow, which is an adaptation of the theory of incompressible flow to vehicular traffic streams. The required input data are travel demand, work zone and freeway capacity, and their variation over time. According to this model, the number of vehicles exiting a particular roadway segment may be lower than those entering the segment when the road segment is inhomogeneous such as in the presence of work zone. The difference between the entering and exiting volume gives the number of vehicles in queue in the upstream direction. The total delay is computed from the delay due to the longer travel time through the work zone and the queue delay time if queue exists. Delay due to longer travel time is equal to the difference between the travel time under “average approaching speed” and travel time under “average work zone speed”. The number of vehicles in queue at a given time is estimated by inflow-outflow analysis. Then the average number of vehicles in queue within a time interval is computed. This number, multiplied by the length of the interval, returns total delay in queue. The methodology underestimates the time that vehicles spent in the queue.

2.1.3.4 WZCAT

The work zone capacity estimation is made based on the suggested methodology in the HCM 2000 (which is the same as 1994 HCM which is the same as 1985 HCM). Alternatively, the user may enter an empirical value for work zone capacity that is based on some field observations. Once the capacity is known, WZCAT compares work zone capacity with the demand volume. If the demand volume is greater than the capacity, the difference is stored in a queue upstream of the work zone. For every six-second interval, WZCAT performs the same input-output analysis and updates the number of excess vehicles stored in queue. In order to estimate the queue length for each period, WZCAT multiplies the number of excess vehicles stored in queue by an average space headway. That average space headway is 40 ft per queued vehicle as suggested by the HCM 2000. Then average delays due to work zone are computed for each period based on the queue length for that period (Lee and Noyce, 2007).

The most recent version of WZCAT is WZCAT-R, which has two major improvements. The first improvement is that WZCAT-R includes all on- and off-ramps upstream of the work zone within reasonable range in delay calculations. The second improvement is the introduction of a traffic flow adjustment factor to account for the reduction in demand due to work zone activities. The software applies three separate traffic flow adjustment factors to mainline, entrance ramps and exit ramps upstream of the work zone. Each traffic flow adjustment factor has two separate values for the two different stages of queue formation: initial queue development and stabilized queue.

2.1.4 Output data for analytical software programs

2.1.4.1 QUEWZ

There are two output options available in QUEWZ (Benekohal, Kaja-Mohideen, and Chitturi, 2003):

- Road user cost: Summary of input data and traffic conditions, additional road user costs for each hour due to lane closure, traffic volumes and the estimated diverting volume.

- Lane closure schedule: The time until which construction activity can go on without leading to excessive delay.

2.1.4.2 QuickZone

There are four types of output data provided by QuickZone (Benekohal, Kaja-Mohideen, and Chitturi, 2003):

- Project delay summary: Expected delay by time-of-day for both a single construction phase and multiple construction phases.
- Travel behavior summary: Number of vehicles that change their departure time, take detour, cancel trip and change their mode.
- Amortized delay and constructions costs: Cost of the project in terms of both delay and infrastructure by year.
- Summary table: Summary of the output data that include queue, delay, travel behavior and cost data for each construction phase and work zone plan; and summary of the input data that include general input data, travel behavior and mitigation strategies. Unlike QUEWZ, Quickzone does not estimate the average speed in the work zone (Chitturi and Benekohal, 2003).

It should be noted that one advantage of QuickZone over QUEWZ is that QuickZone can analyze many interacting work zones and estimate the impact over time by considering changes in traffic control and travel demand by day, week or phase. Thereby, QuickZone can effectively be used to evaluate multiple work plans (Hardy et al, 2007).

2.1.4.3 INTELLIZONE

Three types of output data are provided by INTELLIZONE as follows:

- The convergence results of neural network training in graphical form,
- Hourly queue presented in graphical form,
- A report output that consists of the summary of the work zone input and output information including queue length and delay estimation.

2.1.4.4 WZCAT

For a given work zone, WZCAT returns the following output:

- For a given average vehicle length, WZCAT plots predicted queue development and queue dissipation pattern within the duration of lane closure.
- Vehicle delays due to work zone.

2.2 Micro-simulation software programs

Microscopic simulation software are based on the movement of individual vehicles by car-following and lane-changing algorithms. They can also consider some other parameters associated with driver behavior. Usually simulation software programs are used for a given condition to which analytical models are not applicable. Some of the most-commonly used micro-simulation software programs are CORSIM (the freeway component of it is called FRESIM). Similar software are VISSIM, Paramics and Aimsun.

To compute delay, the travel time of each vehicle is computed in the simulated environment. The difference between the computed travel time and the travel time under the free flowing conditions is the delay experience by the subject vehicle. Simulation software programs have some features like virtual loop detectors by which queue length can be measured for the simulated conditions.

2.2.1 FRESIM

A popular simulation software product that is used to model work zones is FRESIM. CORSIM has two main components FRESIM and NETSIM. FRESIM is for simulation of freeway traffic and NETSIM is for simulation of traffic in intersections. CORSIM was developed by FHWA as part of the TRAF family. The purpose of the TRAF family of simulation programs was to achieve a single integrated simulation system that can simulate traffic flow in freeways and street networks. TRAF and CORSIM are now a part of Traffic Software Integrated System (TSIS) software which has a friendly user interface and output animation capability. FRESIM has the capability of simulating freeways with up to five lanes per direction and lane ramps with up to three

lanes. Lane additions/ drops and freeway blockage incidents can also be modeled. However, work zones cannot be directly modeled by FRESIM. Instead, work zones can be modeled as freeway blockage incidents in FRESIM. In order to model work zones as freeway incidents, the user needs to enter the length of the affected roadway segment, duration of the incident, affected lanes and the rubbernecking factor applied to the adjacent lanes (Benekohal, Kaja-Mohideen, and Chitturi, 2003).

2.2.1.1 Input

There are basically three categories of input data required for running FRESIM

- Geometric: Graphical representation of the network and network information including geometric and detector information, add or drop lanes for the link. Because FRESIM does not directly model work zones, lane closures has to be modeled as incidents on the freeway(Benekohal, Kaja-Mohideen, and Chitturi, 2003):.
- Traffic: The demand volume entering the system, the volume exiting the freeway, and ramp metering information.
- Run control: The random number seeds to generate the random number in the simulation, the probability distribution used in the simulation, the time periods for which the simulation is to be run and reports are to be created, and the warm-up period during which the system comes to an equilibrium and no statistics are yet collected.

2.2.1.2 Output

For each link FRESIM provides many outputs including the following:

- Total travel time,
- Move time,
- Average speed,
- Number of vehicles that entered and exited the link,
- Number of vehicles that are still on the link at the end of the simulation.

The other output data include vehicle minutes and vehicle miles traveled within the network, fuel consumption and emission rates. Unlike the analytical software programs, FRESIM does not compute queue lengths.

2.2.2 Shortcomings of simulation software programs

Although micro-simulation software programs can model individual vehicle movements and provide more detailed output data, they have the following shortcomings that limit their practicality:

- They require much more input data than analytical software programs.
- They are more resource intensive in terms of human and computing power.
- They require data for calibration and validation as well as expertise to know how to do them properly.
- The software programs may not be user-friendly and they may not be readily adapted to the traffic conditions experienced in work zones (Collura et al, 2010).
- Some of the micro-simulation software programs such as FRESIM do not have the capability of directly returning queue lengths.

Some past studies also showed the inadequacy of some micro-simulation packages in estimating work zone capacity, queue length and delay (Collura et al, 2010; Heaslip et al, 2009; Chitturi and Benekohal, 2003).

2.3 *Some other software programs*

2.3.1 ODOT spreadsheet

A spreadsheet application was developed by the Ohio Department of Transportation (ODOT) to estimate queue lengths along a one-lane freeway work zone. The spreadsheet was created using Quattro Pro. Although the spreadsheet is applicable to only one-lane freeway work zones, quick estimates of queue length can be obtained from the spreadsheet with minimal input data. The ODOT spreadsheet requires the following input data (Schnell, Mohror, and Aktan, 2002):

- Work zone capacity under free-flow conditions,
- Work zone capacity under queuing conditions,

- One-way AADT,
- Percent of peak period traffic diverted,
- Number of vehicles in queue per lane mile,
- Hourly volume for each analysis period.

Similar to QuickZone, the ODOT Spreadsheet cannot estimate work zone capacity. Thus, it is important that accurate estimates of work zone capacity are input to obtain accurate estimates of queue lengths.

2.3.2 CA4PRS

Another software program for work zones is CA4PRS (Construction Analysis for Pavement Rehabilitation Strategies), which was developed to support the Long-Life Pavement Rehabilitation Strategies Program of California Department of Transportation in 1998. The software program is targeted at state highway agencies, consultants, design and construction engineers and paving contractors. CA4PRS is mainly used for estimating the maximum probable length of highway pavement that can be reconstructed or rehabilitated under the given project constraints. By using the analysis results, construction and operations can be optimized (Collura et al, 2010).

Although the capabilities of CA4PRS do not include queue length and delay estimation, it is possible to integrate CA4PRS with QUEWZ and QuickZone to estimate road user costs during construction. For some given input data, the number of lane closure windows necessary for a rehabilitation/ reconstruction project can be estimated with CA4PRS. Then the user can enter those lane closure windows into QUEWZ or QuickZone to estimate the corresponding queue length and delay (Collura et al, 2010).

There are four types of input data required to run CA4PRS: project details, scheduling, resource profile, and specific analysis input variables. Most of the input data for CA4PRS are related to the paving contractor rather than the transportation engineer. Once the input data are entered, CA4PRS can perform either deterministic or probabilistic analysis. In the deterministic analysis, the input parameters are treated as

constant. In the probabilistic analysis, each input parameter is treated as a random variable with a particular statistical distribution.

2.4 Comparison of the work zone software programs in the literature

Chitturi and Benekohal (2003) collected field data from 11 freeway work zones and evaluated QUEWZ, QuickZone and FRESIM. They compared the outputs from the three software programs with the field data to find out which one performed better. The results of the comparisons are summarized in Table 2.1 . In evaluating QUEWZ, Chitturi and Benekohal (2003) used both the default values of QUEWZ and “modified” QUEWZ. In the “modified” QUEWZ, Chitturi and Benekohal (2003) modified the passenger car equivalence in the QUEWZ so that the capacities estimated by the QUEWZ matched the field data. Moreover, although FRESIM does not compute queue lengths, Chitturi and Benekohal (2003) estimated the queue lengths from the FRESIM simulation results in view of the average speed and density data for each link.

In Table 2.1, percent differences between the software output and field data are presented. The percent differences in Table 2.1 are computed with respect to the field data. A negative percent difference means the software program underestimated the given variable whereas a positive percent difference means the given variable was overestimated by the software program.

Table 2.1 Comparison of the field data with the software outputs: (a) Range of the percent difference between the software output and field data, (b) Average percent difference between the software output and field data (Chitturi and Benekohal, 2003).

(a)

Range of percent difference of the software output from the field data				
	Capacity	Speed	Queue length	Delay
QUEWZ	3% – (-33%) for the sites without queuing, 7% – 16% for the sites with queuing	(-9%) – 58% for the sites without queuing, 25% – 140% for the sites with queuing	(-35%) – (-100%)	N/A
Modified QUEWZ	N/A	8% – 58% for the sites without queuing, 25% – 56% for the sites with queuing	(-14%) – (-90%)	N/A
FRESIM	N/A	(-7%) – 11% for the sites without queuing, 72% – 106% for the sites with queuing	(-83%) – 94%	N/A
QuickZone	N/A	N/A	(-56%) – 17%	(-14%) – (-38%)

(b)

	Capacity	Speed	Queue length	Delay
QUEWZ	-20% for the sites without queuing, 11% for the sites with queuing	15% for the sites without queuing, 71% for the sites with queuing	-78%	N/A
Modified QUEWZ	N/A	25% for the sites without queuing, 41% for the sites with queuing	-64%	N/A
FRESIM	N/A	2% for the sites without queuing, 92% for the sites with queuing	-70% when underestimated, 78% when overestimated	N/A
QuickZone	N/A	N/A	-23%	-29%

According to the results in Table 2.1 (Chitturi and Benekohal, 2003):

- None of the software programs returned estimates of capacity, speed, queue length or delay that matched the field data.

- For the sites without queuing, QUEWZ was found to underestimate capacity and overestimate average speeds. On the other hand, it was found to overestimate capacity and average speeds for the sites with queuing. It was also found to underestimate queue lengths.
- The discrepancies were expected because the capacity estimates returned by QUEWZ did not match the capacities observed in the field.
- When “modified” QUEWZ was used, the passenger car equivalence was modified so that the capacity estimates returned by QUEWZ matched field data. However, even in that case, the average speeds were overestimated and the queue lengths were underestimated.
- The discrepancies might be attributed to the speed-flow relationship that QUEWZ uses because the speed-flow relationship does not consider work zone characteristics such as work intensity or work zone configuration (Chitturi and Benekohal, 2003; Jiang and Adeli, 2004).
- For the sites without queuing, there were with very little discrepancies between the average speeds estimated by FRESIM and field data. A paired t-test showed that the discrepancies were not significant at 95% confidence level.
- For the sites with queuing, FRESIM overestimated average speeds. In half of the cases, FRESIM underestimated the queue lengths and in the other half, FRESIM overestimated the queue lengths.
- QuickZone was found to generally underestimate the queue lengths and delay.

On the other hand, Collura et al (2010) evaluated QuickZone and QUEWZ in terms of their accuracy in queue length estimation. They compared the field data from four work zones in New England with the outputs from both QuickZone and QUEWZ. Those four sites were observed to exhibit varying queue lengths ranging from 0.5 mi to 6.0 mi. According to the results, Collura et al (2010) concluded that both software programs provided fairly accurate estimates of the actual queue lengths. However, the authors did not compare the accuracy of the software programs with each other and did not give the percent errors with respect to field data.

In another software evaluation study, Schnell, Mohror and Aktan (2002) compared the accuracy of Synchro/ SimTraffic, QUEWZ and ODOT (Ohio Department of Transportation) spreadsheet in estimating queue lengths due to work zones. They collected field data from four work zones in Ohio and compared the software outputs with the field data. A summary of the results are presented in Table 2.2.

Table 2.2: Comparison of the field data with the software outputs: (a) Queue lengths, (b) Percent difference between the software output and field data

(Schnell, Mohror and Aktan, 2002).

(a)

	Queue length (mi)			
	Synchro/ SimTraffic	QUEWZ	ODOT Spreadsheet	Field data
Site 1 (Cambridge)	1.0	3.0	5.7	5.5
Site 2 (Cambridge)	4.0	2.8	5.2	6.2
Site 3 (Columbus)	2.0	2.1	2.7	3.2
Site 4 (Sandusky)	1.6	N/A	2.6	2.3

(b)

	Percent difference from the field data		
	Synchro/ SimTraffic	QUEWZ	ODOT Spreadsheet
Site 1 (Cambridge)	-82%	-45%	4%
Site 2 (Cambridge)	-35%	-55%	-16%
Site 3 (Columbus)	-38%	-34%	-16%
Site 4 (Sandusky)	-30%	N/A	13%

According to the results in Table 2.2:

- Both Synchro/ SimTraffic and QUEWZ underestimated the queue lengths. The average percent error was higher for Synchro/ SimTraffic. The ODOT spreadsheet provided the closest estimates of the queue lengths. In two of the cases, it slightly

underestimated the queue length whereas in the other two cases, it slightly overestimated the queue lengths.

- Although the queue length estimates returned by QUEWZ were not that close to the field data, QUEWZ performed better in estimating the work zone capacities at the four sites. Schnell, Mohror and Aktan (2002) compared the work zone capacities returned by QUEWZ with the field data for the four study sites. According to the results, the capacity estimates by QUEWZ differed from the field data by 1.4% – 10.7% with an average percent difference of only 6.25%. So in that study, QUEWZ provided close estimates of work zone capacity compared to the field data.

Next, Lee, Noyce, and Qin (2008) collected field data from eight short-term freeway work zones in Wisconsin to evaluate the accuracy of WZCAT-R in predicting queue lengths. They used the data from three of those eight work zones to evaluate the WZCAT-R estimates of queue length. The results are summarized in Table 2.3. All the percent differences in Table 2.3 are computed with respect to the field data. Although some of the percent differences shown in Table 2.3 exceeds 100%, few of the results show fairly good agreement between the field data and WZCAT-R outputs.

Table 2.3 Comparison of the field data with the queue length estimates from WZCAT-R Lee, (Lee, Noyce, and Qin, 2008)

		Work zone hours							
		8	9	10	11	12	13	14	15
Site 1	Estimated queue length (mi)	0.00	1.85	2.25	2.87	2.93	3.43	4.50	3.77
	Observed queue length (mi)	1.90	2.70	3.30	3.60	2.70	2.60	3.10	3.50
	Percent difference	-100%	-31%	-32%	-20%	9%	32%	45%	8%
Site 2	Estimated queue length (mi)	1.64	3.34	3.43	4.07	4.90	5.35	2.83	
	Observed queue length (mi)	1.90	2.70	3.30	3.60	2.70	2.60	3.10	
	Percent difference	-14%	24%	4%	13%	81%	106%	-9%	
Site 3	Estimated queue length (mi)	0.10	1.53	1.09	1.21	1.83	3.26	0.00	
	Observed queue length (mi)	0.30	0.75	0.80	0.90	1.28	1.35	0.50	
	Percent difference	-67%	104%	36%	34%	43%	141%	-100%	

2.5 *Summary*

Two types of software programs can be used to estimate queue length and delay in work zones: analytical software programs and micro-simulation software. Some of the analytical software programs are QUEWZ, QuickZone, INTELLIZONE, WZCAT. On the other hand, FRESIM, Synchro/ SimTraffic, Paramics, and VISSIM are among the popular software simulation programs. Although those programs may be useful in estimating queue lengths and delay in work zones, they have the following shortcomings:

- The current capacity models in the analytical programs are not adequate. Because there are several work zone features like presence of flagger, and presence of ITSs

which were not reflected in the models. These work zone features are regularly observed in work zones.

Usually, micro-simulation packages are used when analytical software programs are not applicable to a traffic condition. Using micro-simulation packages has some shortcomings:

- Working with simulation programs is not as convenient as working with analytical models. Because overall, simulation programs need more input data. Also unlike the analytical programs, they need calibration. The calibration of micro-simulation software programs is resource intensive and they may not be easily adapted to local traffic conditions.
- Micro-simulation software programs apply some behavioral rules to simulate drivers' reactions and vehicles motion. However the behavior of drivers in work zones is not well known. For instance reactions of drivers to ITSs in work zones need to be studied.

Beside the above-mentioned issues, some past studies showed the inadequate accuracy of some software programs in estimating work zone queue length and delay (Collura et al, 2010; Lee, Noyce, and Qin, 2008; Chitturi and Benekohal, 2003; Schnell, Mohror and Aktan, 2002).

Considering the shortcomings of the existing software programs for estimating work zone queue length and delay, a new software program is needed that can:

- Accurately estimate work zone capacity under various geometric and traffic control conditions,
- Accurately model both moving queue and stopped queue in work zones.

2.6 References

Benekohal, R. F., A.-Z. Kaja-Mohideen, and M. V. Chitturi, Evaluation of Construction Work Zone Operational Issues: Capacity, Queue and Delay. Illinois Department of Transportation, Project IVA-H1, FY 00/01, Report No. ITRC FR 00/01-4, December 2003.

Chitturi, M. C., and R. F. Benekohal. Comparison of QUEWZ, FRESIM and QuickZone with Field Data for Work Zones. CD-ROM, Transportation Research Board 84th Annual Meeting, Transportation Research Board, Washington, D.C. 2004.

Collura, J., K. P. Heaslip, K. Moriarty, F. Wu, R. Khanta, and A. Berthaume. Simulation Models for Assessment of the Impacts of Strategies for Highway Work Zones: Eight Case Studies Along Interstate Highways and State Routes in New England. In Transportation Research Record: Journal of the Transportation Research Board, No 2169, Transportation Research Board of the National Academies, Washington, D.C., 2010, pp. 62–69.

Hardy, M, and K. Wunderlich. Traffic Analysis Tools Volume VIII: Work Zone Analysis – A Guide for Decision-Makers. U.S. Department of Transportation, Federal Highway Administration, Office of Operations, Report No. FHWA – HOP-08-029, July 2008.

Hardy, M, and K. Wunderlich. Traffic Analysis Tools Volume IX: Work Zone Modeling and Simulation – A Guide for Analysts. U.S. Department of Transportation, Federal Highway Administration, Office of Operations, Report No. FHWA – HOP-09-001, March 2009.

Heaslip, K., A. Kondyli, D. Arguea, L. Elefteriadou, and F. Sullivan. Estimation of Freeway Work Zone Capacity through Simulation and Field Data. In Transportation Research Record: Journal of the Transportation Research Board, No 2130, Transportation Research Board of the National Academies, Washington, D.C., 2009, pp. 16–24.

Jiang, X., and H. Adeli. Freeway Work Zone Traffic Delay and Cost Optimization Model. *Journal of Transportation Engineering*, Vol. 129, No. 3, May 2003, pp. 230–241.

Jiang, X., and H. Adeli. Object-Oriented Model for Freeway Work Zone Capacity and Queue Delay Estimation. *Computer-Aided Civil and Infrastructure Engineering*, Vol. 19, 2004, pp. 144–156.

Karim, A., and H. Adeli. Radial Basis Function Neural Network for Work Zone Capacity and Queue Estimation. *Journal of Transportation Engineering*, Vol. 129, No. 5, September 2003, pp. 494–503.

Lee, C., D. A. Noyce, and X. Qin. Development of Traffic Delay Assessment Tool for Short-Term Closures on Urban Freeways. In *Transportation Research Record: Journal of the Transportation Research Board*, No 2055, Transportation Research Board of the National Academies, Washington, D.C., 2008, pp. 39–48.

Memmott, J. L. The HEEM-II Benefit-Cost Computer Program. Report No. FHWA/TX-92/1128-1F, Texas Transportation Institute, College Station, TX, 1991.

Schnell, T., J. S. Mohror, and F. Aktan. Evaluation of Traffic Flow Analysis Tools Applied to Work Zones Based on Flow Data Collected in the Field. In *Transportation Research Record: Journal of the Transportation Research Board*, No 1811, Transportation Research Board of the National Academies, Washington, D.C., 2002, pp. 57–66.

CHAPTER 3. CAPACITY ESTIMATION

3.1 *Introduction*

Capacity can be measured by various methods. Based on the definition of capacity in the HCM 2000, one can measure capacity as the maximum 15-minute flow rate. On the other hand, presence of large gaps between vehicles is one of the issues in capacity measurement. In this chapter, it is investigated how the presence of large gaps impacts estimations if capacity is determined as the maximum 15-minute flow rate. Field data are used to analyze the severity of the impact for these three conditions: pre-break down, break down and post-break down conditions. Alternative methods of capacity measurement, less affected by large gaps are reviewed.

3.2 *Field data*

Field data collected from I-74EB and I-55SB are used for the analyses. General information of the sites is shown in Table 3.1.

Table 3.1: General information of data collection sites

Site	Mile Post	Speed Limit	Type of work zone	Work activity
I-55SB	55	45	Long term	Moderate (WI=4)
I-74EB	5	55	Long term	No work activity

One of the two lanes was closed within the work zone. Data collected by videotaping and speed, headway and type of each individual vehicles were available. Details of data collection and reduction were explained by Benekohal et al. (2003) .

About 238 and 178 minutes of data are available for I-55SB and I-74EB respectively. Flow rate and average speed were computed for each two min. interval. Variation of average speed and flow rate over time are shown in Figure 3-1 and Figure 3-2 for I-55SB and I-74EB, respectively.

Pre-break down and break down data are available for I-55SB. Field notes showed that breakdown occurs at minute 152. Also in Figure 3-1, average speed varies between 27 mph and 52 mph until minute 152 and right after, there is an about 16 mph speed drop and speed maintains between 12 mph and 27 mph for 86 minute.

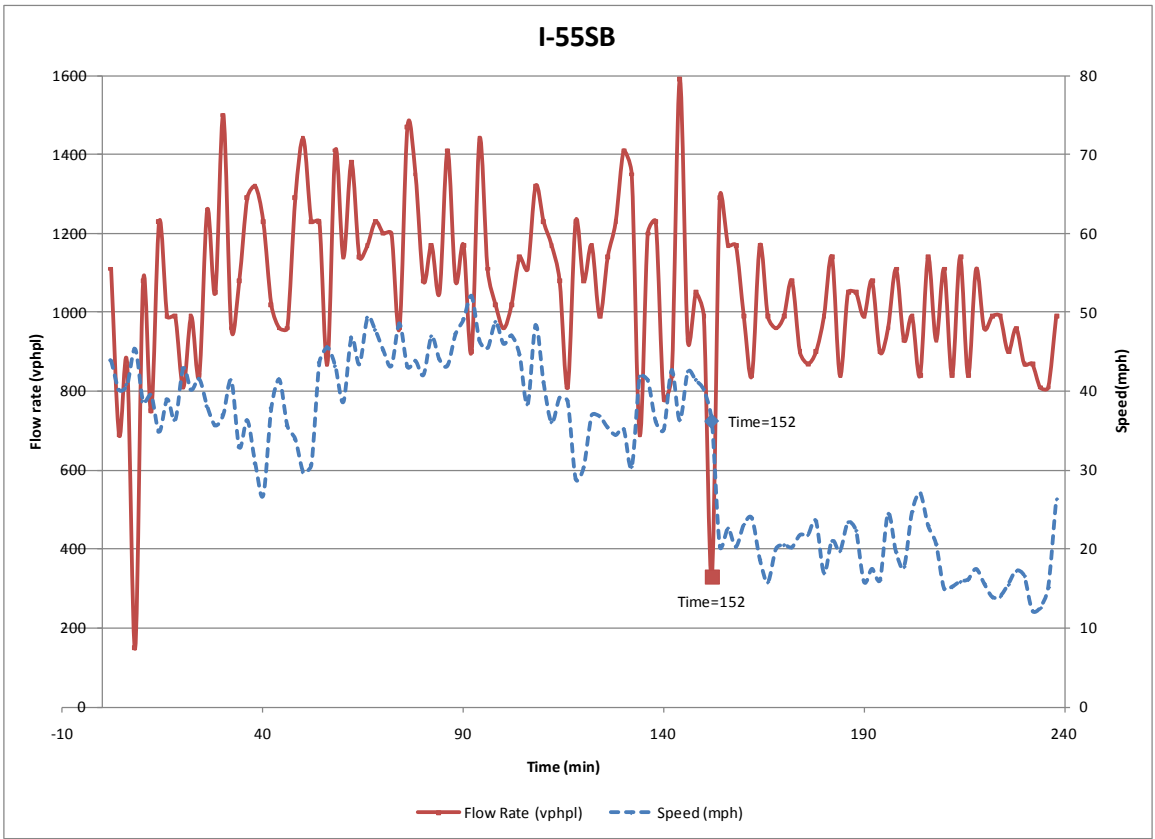

Figure 3-1: Two- minute Speed and Flow Data for I-55SB

Data from break down and post break down conditions were collected in I-74EB. Based on the field notes, traffic was in break down condition from the beginning of the data collection to minute 136 and during this time, average speed varies between 14 mph and 31 mph. Then there is a speed increase of about 17 mph between minutes 136 and 138 and field data showed that there is no longer queuing condition. Thereafter, speed varies between 40 mph and 52 mph.

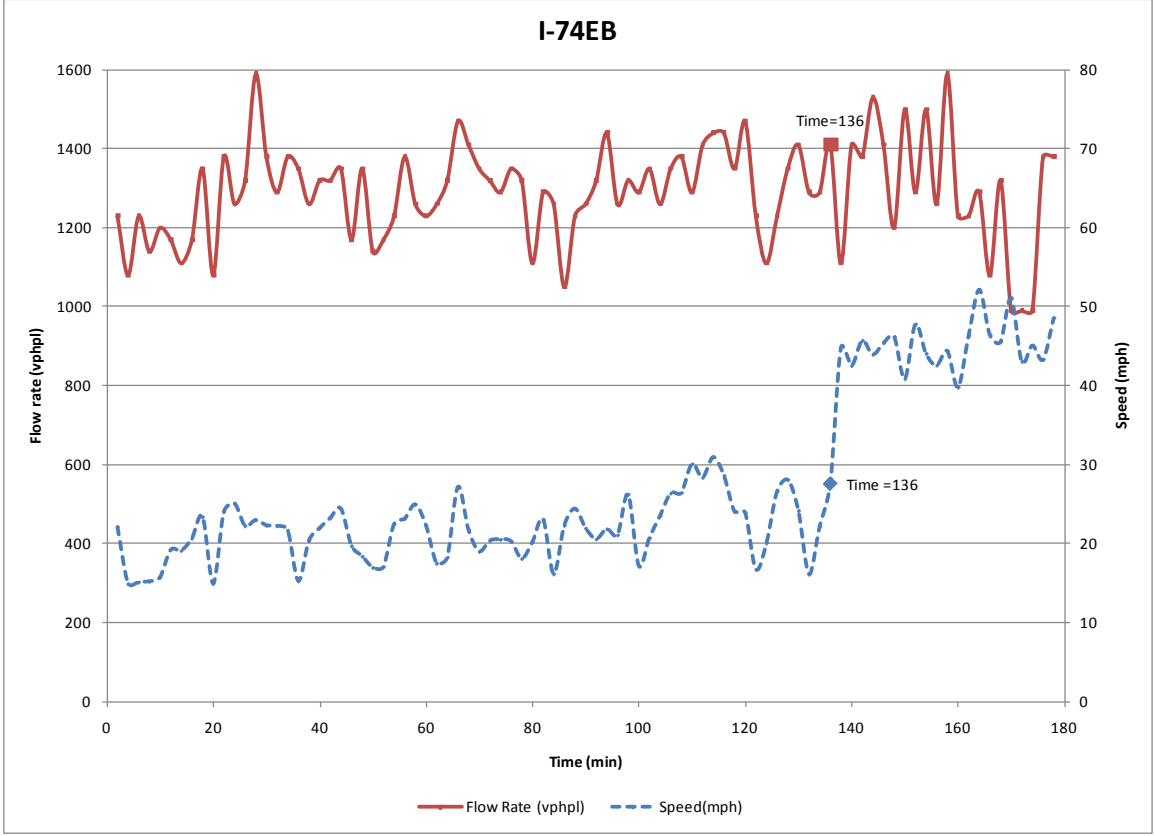

Figure 3-2: Two- minute Speed and Flow Data for I-74EB

3.3 Methodology

In this section, field data are used to investigate the effect of large gaps on capacity estimation. For this purpose, platoon ratio which is an indication of the presence of large gaps, is defined as:

3-1

Where

=Flow rate observed in field. The number of vehicles passing a particular section of the roadway is counted within a given interval. The flow rate corresponding to this volume is the observed flow rate.

)=computed as:

3-2

=average headway of all in-platoon vehicles in medium and large platoons. In-platoon vehicles have either a headway of less than four second or spacing of less than 250 ft. Medium and large platoons have a platoon size of greater than 4. Platoon size is the number of vehicles in a platoon, including the leader of the platoon.

can be interpreted as the flow rate when all vehicles are in platoon and there is no large gaps between vehicles. When platoon ratio is close to 1, it means that most of the vehicles are in platoon and medium and large gaps do not substantially influence capacity measurement. The lower the platoon ratio, the more large and medium gaps in the traffic.

Platoon ratio is computed for each two-minute interval. Shorter interval was not selected since it may show some flow rate which stays for few moments and is unstable. On the other hand, very larger intervals may mask some traffic condition which might be necessary to be investigated.

Platoon ratio versus are plotted for three traffic conditions: 1) Pre-break down 2) Break down 3) Post-break down. By looking at the plots, the correlation between platoon ratio and observed capacity is analyzed for the three conditions. Also, it will be investigated that if capacity is determined based observed flow rate, what platoon ratio

will be associated to the estimated capacity. If the corresponding platoon ratio is significantly lower than one, the estimation is suffering from presence of large gaps due to lack of demand.

3.4 Findings

Figure 3-3a and b , show platoon ratios versus the observed flow rate for pre-break down and post break down conditions, respectively.

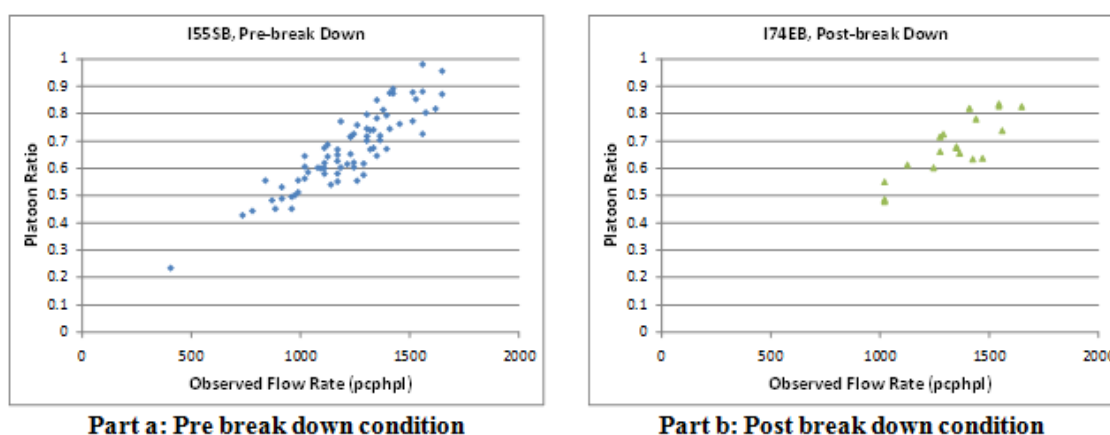

Figure 3-3: Platoon Ratio Versus Observed Flow Rate for a) Pre-break Down and b) Post-break Down Conditions

There is an increasing trend between platoon ratio and the observed flow rate. For pre-break down condition the ratio varies between 0.48 and 0.83 and the observed flow rate varies between 1200 and 1650 pcphpl. For Post-break down condition, the platoon ratio ranges from 0.23 to 0.98 and the observed flow rates are between 405 and 1650 pcphpl.

Figure 3-4 displays platoon ratio for break down condition at I-55SB and I-74EB respectively. platoon ratio ranges from varies from 0.74 to 1 for I-55SB and from 0.91 to 1 for I-74EB. Observed flow rates in I-55SB are between 855 pcphpl to 1350 pcphpl while those in I-74EB are between 1125 pcphpl to 1605 pcphpl. Overall Platoon ratios for I-74EB are higher than those for I-55SB. One of the possible reasons for this difference could be that the range of flow rates at I-74EB are higher than those at I-55SB.

Hence more vehicles were processed in I-74EB and less large gaps were between vehicles. The similarity between these two sites is that most of the platoon ratios are high and close to one. This is expected as the data belong to the break down condition and most of the vehicles are in a queue.

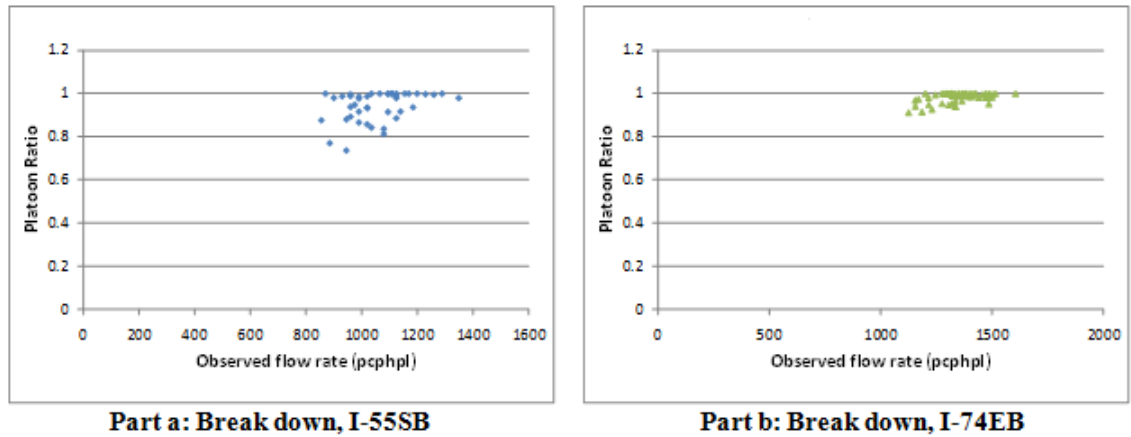

Figure 3-4: Platoon Ratio Versus Observed Flow Rate for Break Down Condition at a) I-55SB and b) I-74EB

The relatively low ranges of platoon ratio for pre-break down and post-break down conditions show the presence of large gaps in traffic. While large gaps between vehicles in break down condition are much less than those in non-break condition.

The presence of large gap may cause underestimation if capacity is determined based on the maximum observed flow rate. In particular, if capacity is defined as the maximum 15-minute flow rate, the pre-breakdown capacity will be roughly (rounded to the nearest multiple of 50) 1350 pcphpl. Also, platoon ratio for the corresponding interval is 0.74. The maximum 15-min flow rate of the post-break down condition is roughly 1450 pcphpl while the corresponding platoon ratio is 0.73. The low platoon ratio implies that the volume is not at the capacity level and estimations are suffering from the presence of large gaps or lack of demand.

The maximum 15-minute flow rates at break down condition are 1174 pcphpl and 1436 pcphpl for I-55SB and I-74EB respectively. The corresponding platoon ratios are

0.96 and 0.99, respectively which implies that the estimations are not practically influenced by the presence of large gaps. This is expected as in queuing conditions, as demand is more than capacity and there is no lack of demand.

3.5 Discussion

Capacity was determined as the maximum 15 minute flow rate for the field data, available. Data analysis showed that the presence of large gaps caused underestimation of pre-break down and post-break down capacity; However it is not practically a critical issue for the break-down capacity estimation. Hence new method of capacity estimation is needed to resolve the issue of large gaps.

Benekohal et al. (2010), evaluated four methods of capacity estimation to resolve the issue. The methods are: 1) The Maximum 15-min Flow Rate 2) The “h-n” Method 3) All In-platoon Vehicles 4) Vehicles In Large And Medium Platoons. Methods were applied to field data and advantages and disadvantages of each method were discussed. Based on the discussion, the following capacity estimation model was proposed

$$C_E = C_P * f_P \quad 3-3$$

Where

C_E = Estimated operating capacity in pcphpl

C_P = Potential capacity on pcphpl, computed by Equation 3-2.

f_P = Platooning factor

The potential capacity is the capacity assuming that the road is fully utilized by vehicles under capacity conditions. Potential capacity might be a reasonable estimation of operating capacity, C_E , in break down condition since all vehicles are in a long queue and road is almost fully utilized. Hence a platoon factor of 1 was suggested for break down condition and when average speed is less than 35 mph. On the other hand in post-break down and pre-break down capacity level, vehicles are in platoons instead of being in a large queue. Hence there are some gaps between platoons at capacity level and that implies that the road may not be fully utilized. Hence the potential capacity may not be a

reasonable estimation of operating capacity. For these cases, platoon factors of less than one were suggested to be applied in Equation 3-3. Based on the field data, platoon factors of 85% for short term work zones, 90% for long term and long-distance work zones, and 95% for long term and short-distance work zones were suggested to use in Equation 3-3. It should be noted that a short-distance work zone is a work zone where drivers are able to see the end of the work zone when they enter the transition area and consequently, it requires less-than-a-minute travel time at highway speed to exit the work zone.

Furthermore Benekohal et al. (2010) also suggested capacity for several work zone conditions, shown in Table 3.2. The suggested values are based on field data analysis and further details of analysis are provided in Benekohal et al. 2010. Break down capacity of 1200 pcphpl was suggested when flagger is present in the work zone and speed limit is 45 mph. The other capacities were suggested for non-break down conditions: post-break down and pre-break down conditions. The suggested non-break down capacities ranges from 1400 pcphpl to 1550 pcphpl when speed limit is 45 mph. It is also varies between 1600 pcphpl and 1750 pcphpl for speed limit of 55 mph. As expected, the suggested capacity for the break down condition has the lowest value. Also, the capacities suggested for work zones with speed limit of 55 mph are higher than those suggested when speed limit is 45 mph.

There are some other work zone conditions which were not referred to in Table 3.2, like presence of Speed Photo Enforcement (SPE), and Changeable Message Sign (CMS). Field data collection and analysis is recommended for these conditions. Moreover, there are some issues related to non-break down capacity that should be investigated. Field data collection is recommended to study if post-break down and pre-break down capacities are practically different for a given site. The relationship between the platooning factor and the potential capacity of post-break down conditions versus those of pre-break down conditions are needed to be investigated.

Table 3.2: Suggested Capacity Values for Different Work Zone Conditions

Traffic Condition	Speed Limit (mph)	Work Zone Condition	Suggested capacity (pcphpl)
Break down		Flagger, queue	1200
Non-break down	45	Low work activity, flagger, dynamic speed feedback sign no queue	1400
		No work activity, no queue	1550
		No work activity, with police, no queue	1450
		No work activity, dynamic speed feedback sign, no queue	1600
	55	No work activity, no queue, short distance work zone	1750
		No work activity, no queue	1700

3.6 Reference

R. Benekohal, H. Ramezani, K. Avrenli, (2010), Delay and User's Cost in Highway Work Zones, Research Report ICT-10-075. Retrieved from <http://ict.illinois.edu/publications/report%20files/FHWA-ICT-10-075.pdf>

CHAPTER 4. INTERMITTENT QUEUE

This section discusses intermittent moving queue and continuous moving queue. Intermittent moving queue happens when a moving queue lasts for a short time period (for example 5-15 minutes) followed by a short period without the queue presence, and then queuing condition occurs again. In intermittent moving queue condition, there are queuing intervals, each surrounded by non-queuing periods. On the other hand, in continuous moving queues, there is a single interval where queuing condition exist.

The difference between the queue types is illustrated using field data. Field data were collected from I-39NB and I-80EB, in Illinois. In both sites, one of the two lanes was closed due to construction activities. A flagger with “Slow Down” paddle was present at each site and vehicles reduced their speeds in response to the flagger. The speed reduction caused queuing at some time periods. . The extent of queue (queue length) was recorded at minute intervals by an observer. Figure 4-1-a and Figure 4-1-b show the queue length data collected from I-39NB and I-80EB, respectively.

Figure 4-1-a displays the pattern of a continuous moving queue at I-39NB. Queue starts propagating at minute 14. Overall, queue length increases until the minute 25 when the queue length is 4,680 ft long, and thereafter queue length reduces and finally at the minute 38 queue vanishes.

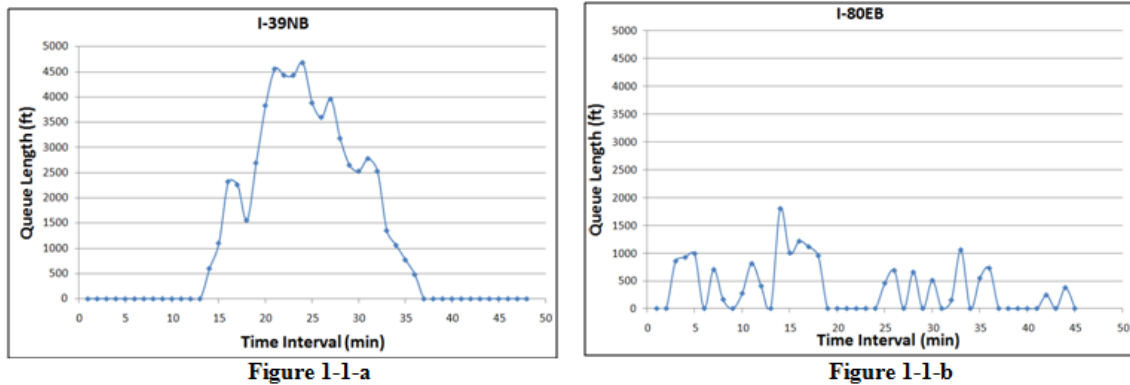

Figure 4-1: Moving Queue Types: a) Continuous Moving Queue, and b) Intermittent Moving Queue

On the other hand Figure 4-1-b, demonstrates the pattern of an intermittent moving queue. Queue length increases from minute two to minute five, and after that queue disappears at the end of the minute six. Similar patterns of queuing and no queuing occurs several times.

The maximum intermittent queue length was about 1,800 ft. While the maximum continuous queue length, in Figure 4-1-a, was 4,680 ft.

4.1 Problem Statement

An approximate methodology to estimate continuous moving queue length, and its delay, was proposed by Benekohal et. al (2010). The methodology assumed queue length varies linearly within an analysis interval since arrival rate is uniform. When the length of the analysis interval is short (one minute or so) the linearity assumption yields reasonable results. However, for longer intervals (for example 5 , 10, 15 min) the assumption of linear variation of queue length may not be valid. For example, Figure 4-1-b shows there was no queue at the end of the minute one and minute 20. If it was assumed that a continuous moving queue was present during the 20 minute interval, the intermittent queuing condition would not have been detected because the demand in the

20-min interval was less than the capacity. While the field data showed that there was queuing condition in the middle of the interval and the queue length did not vary linearly.

In this chapter, a methodology to estimate intermittent queue length and delay is developed. It is able to estimate delay and queue length that last for a portion of the analysis interval and the arriving volume of the entire interval is less than capacity of the interval.

4.2 Methodology

To analyze intermittent queues, it is important to know the mechanism of intermittent queue formation. Queuing condition happens whenever demand is more than capacity. In the data shown in Figure 4-1-b, demand intermittently exceeds capacity for several minutes and then returns below the capacity. Assuming that capacity of bottleneck is fixed, it can be concluded that arrival rate falls above and below the capacity, and this implies that arrival pattern is not uniform. The proposed methodology assumes that vehicles are moving in separate groups whose minimum size is one. The group size of one belongs to single free flowing vehicles and if the size is more than one the group will be a platoon of vehicles.

Figure 4-2, shows the cumulative arrival pattern assuming that vehicles are traveling in separate groups. The whole analysis interval is divided into two sets of subintervals: T_i 's and Y_i 's. T_i represents a subinterval during which group i arrives at the bottleneck. The time gap between arrivals of group i and group $i+1$ is Y_i . A group of vehicles (n_i) arrive the bottleneck within T_i interval, but no vehicle arrives during Y_i . This arrival pattern happens cyclically hence cycle i , C_i , is defined as the summation of Y_i and T_i .

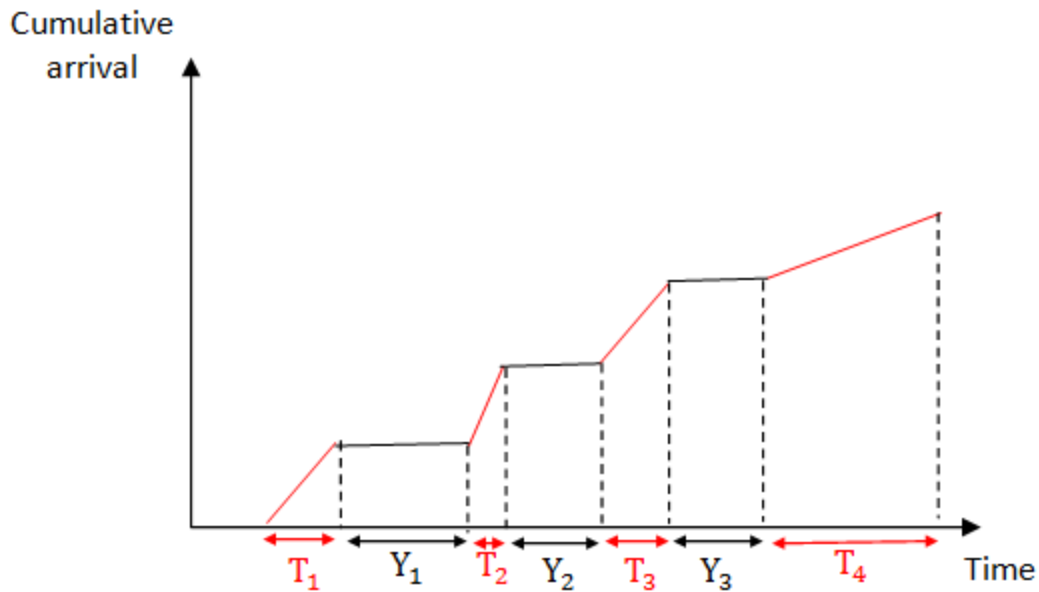

Figure 4-2: Cumulative Arrival for Vehicles Moving in Separate Groups

Groups may have some interaction with each other. For example in Figure 4-2, the group one reaches the bottleneck during T_1 and no arrivals occur within Y_1 , until the group two reaches the bottleneck. It is assumed that the arriving rate of the first group is more than capacity thus the backward shockwave starts propagating as soon as the group one reaches the bottleneck. If Y_1 is short enough, the second group reaches the bottleneck before departing the first group. In this case, the groups have interaction with each other. On the other hand, if Y_1 is large enough, all vehicles in the first group leave the bottleneck before arriving the next group.

In the following sections, first the group characteristics used as input variables are introduced. Second, a methodology is developed to estimate intermittent queue length and delay for one cycle. Third, a model is developed for an analysis interval which includes several cycles. The above models are proposed for a particular case in which groups have interaction with each other and overall, the queue length increases. Fourth, it is shown how the suggested methodology can be used for other possible cases.

4.2.1 Group characteristics

The characteristics of each group which is necessary for modeling are listed and defined as below:

n_i =The size of the group i which is the number of vehicles in the group i . The minimum group size is one in which case the group is a single free flowing vehicle. The group size for a platoon of vehicles is two or more.

\bar{h}_i =Average headway of vehicles in the group i , excluding the leader of the group and is computed using the following equation :

$$\bar{h}_i = \frac{1}{n_i - 1} \sum_{j=2}^{n_i} h_{ij} \quad 4-1$$

Where j is the order of the vehicles in the group i and n_i is the size of the group i .

If the group size, n_i , is zero, it will be assumed that, \bar{h}_i , is zero.

T_i =The time during which the group i enters the bottleneck and estimated as:

$$T_i = \frac{L}{v} + \bar{h}_i \quad 4-2$$

Where

\bar{h}_i =The average headway of all in-platoon vehicles following platoon leaders during the entire analysis interval. (Headways of platoon leaders are not included)

The Equation 4-2 computes the time that a group of vehicles requires to pass a section of the roadway. When the group size is more than one, the group has a leader and some followers. The actual headway of followers is considered as the time each follower needs to pass the section. However, it is assumed that the time that a leader needs to pass the section is equal to the average headway of its followers and estimated from Equation 4-1. When group size is one, \bar{h}_i , is the interval duration assigned to the leader.

Y_i =the time gap between the arrival of the groups i and $i+1$.

Queue length and delay for a cycle

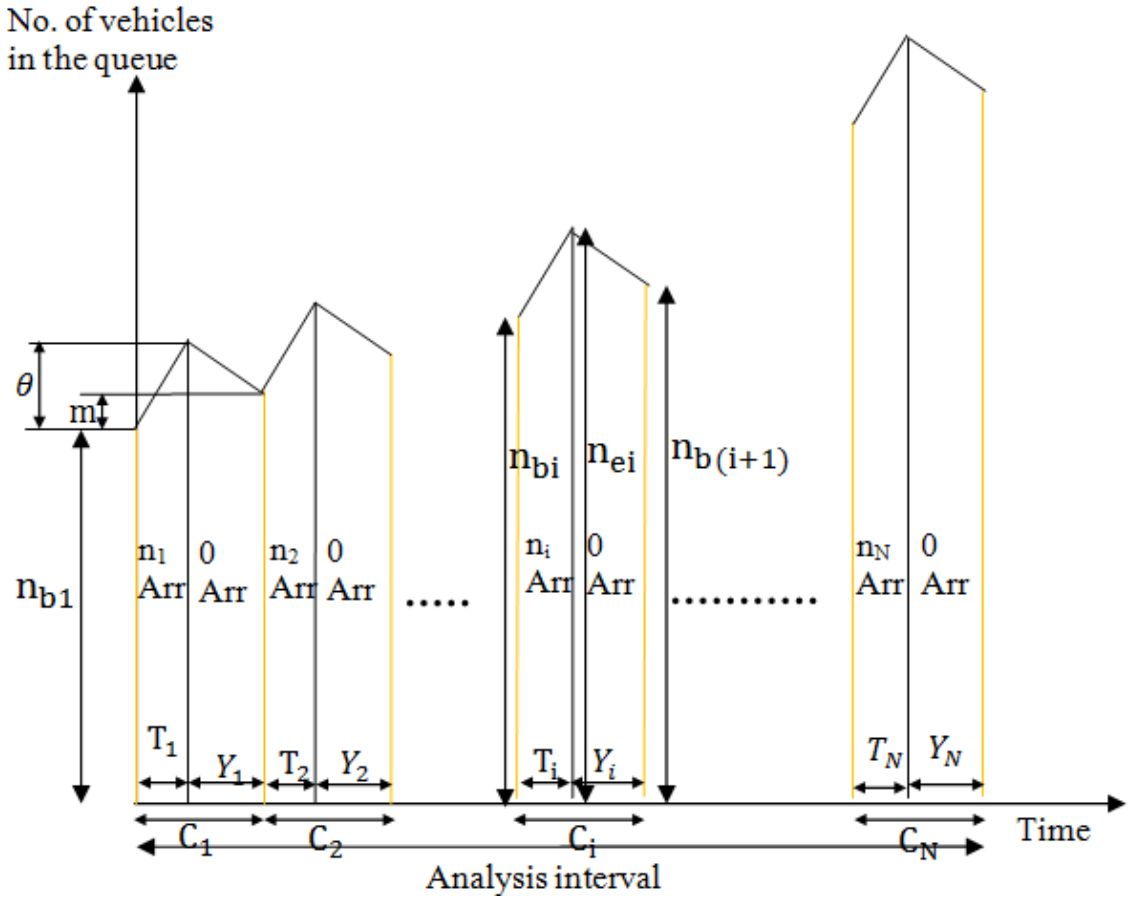

Figure 4-3, shows the number of vehicles in the queue versus time. Arrival of n_i vehicles occurs during T_i , and since it is assumed that the arrival rate is greater than the departure rate, vehicles in group i have to slow down. It is assumed that the number of vehicles in the queue at the beginning of the T_i is n_{bi} and the number of vehicles in the queue at the end of T_i is n_{ei} .

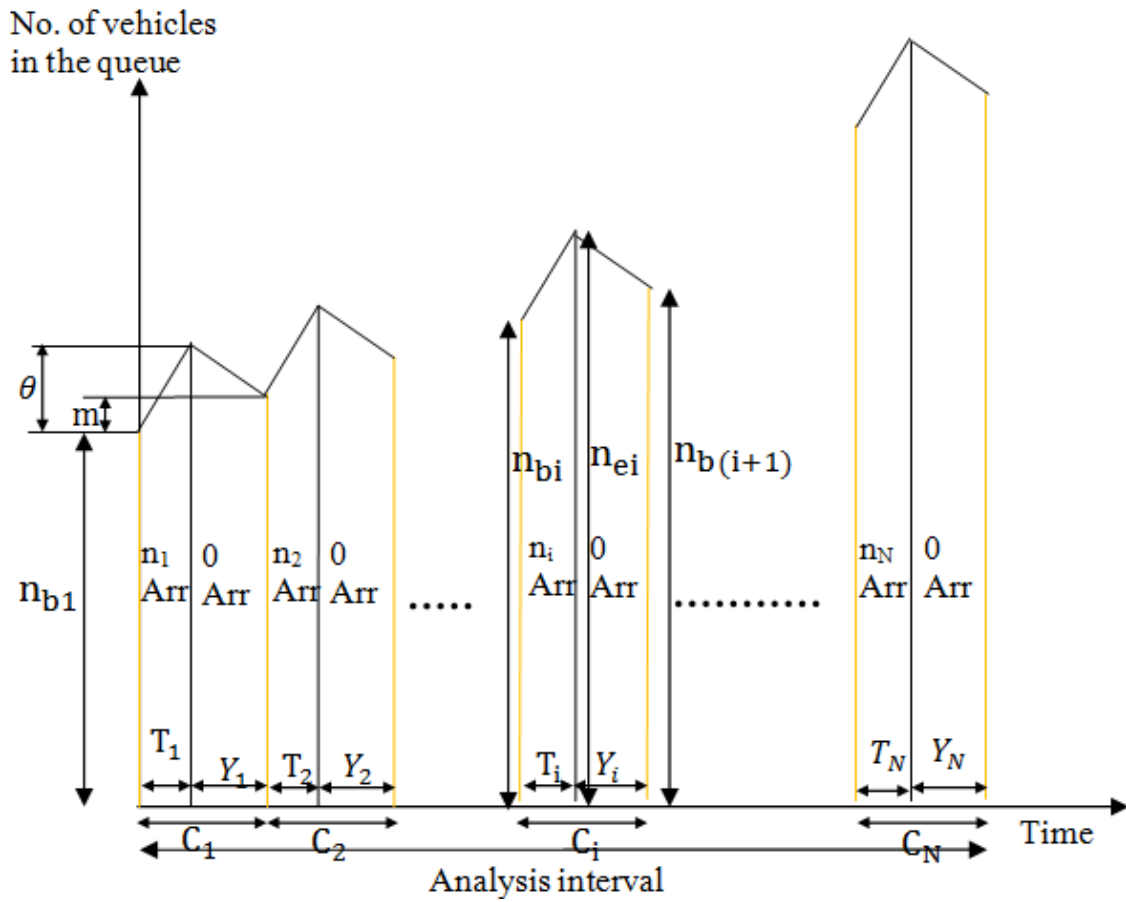

Figure 4-3: Number of Vehicles in the Intermittent Queue for Different Cycles

The following relationship is obtained by inflow-outflow analysis during T_i :

$$4-3$$

Where

and n_{bi} = The number of vehicles in the queue in the beginning and the end of the cycle i , respectively.

n_i = The size of the group i , arriving during the

=Adjusted capacity in vphpl

=Duration of time group i arrives, in hour

Likewise the number of vehicles at the end of the cycle i or equivalently the number of vehicles at the beginning of T_{i+1} , is obtained by inflow-outflow analysis during the cycle i :

4-4

Where

= The cycle length (hr) which is equal to summation of and

Total delay during a cycle is computed as below:

4-5

Where

=Total delay experienced by vehicles arriving during

=Total delay experienced by vehicles arriving during

=Total delay experienced by vehicles arriving during

Arriving volume during 's is zero, thus is zero and

4-6

The value of is computed using Equation 4-7:

$$\text{---} \text{---}$$

4-7

Where

- =The size of the group i which arrives during t_i ,
- =Average delay experienced by each vehicle arriving during t_i ,
- =Average speed in the queue during the cycle i ,
- =Average free flow speed during the cycle i ,
- =Average queue length during t_i , which is obtained as below:

$$\text{---} \tag{4-8}$$

Where

=Average number of vehicles in the queue within

X_i =average spacing between vehicles in the queue during t_i and estimated as follow:

$$\text{---} \tag{4-9}$$

Combining Equations 4-7 and 4-8, the following relationship can be used to estimate total delay for the vehicles arriving within the cycle i :

$$\text{---} \tag{4-10}$$

4.2.2 Total delay during the analysis interval

Total delay for several cycles is:

$$\text{---} \tag{4-11}$$

Where

D =total delay (hr)

N=total number of groups in the analysis interval

If it is assumed that all groups have the same characteristics, Equation 4-11 can be simplified to;

$$\frac{N \cdot X \cdot n \cdot v}{v_f} \quad 4-12$$

Where

X= average spacing of the vehicles in the queue,

n=Average group size,

=Average speed in the queue,

=Free flow speed,

=Average number of vehicles in the queue during , and

N=Total number of groups in the analysis interval

The average number of vehicles in the queue within each , , is computed from the following relationship:

$$\frac{N \cdot X \cdot n \cdot v}{v_f} \quad 4-13$$

Where

4-14

=The number of vehicles in the queue in the beginning of the

On the other Equation 4-4, expresses the relationship between and which is rewritten as below

4-15

Where

4-16

Since it was assumed the all groups are identical, m and are the same for all cycles and are not subscribed.

From Equations 4-13 to 4-16 , the average number of vehicles in the queue within is computed as below:

- 4-17

Where

=The number of vehicles in the queue at the beginning of the analysis interval,

i=The order of the corresponding cycle.

Substituting the right hand side of Equation 4-17, for in Equation 4-12, the total delay is computed as:

- - - 4-18

Figure 4-4 shows the average number of vehicles computed for each . The term - in Equation 4-18, represents the average number of vehicles in the

queue over T_i 's. In particular, \bar{n} is the average number of vehicles in the hatched rectangle and \bar{n}_i is the average number of vehicles represented by the white bars.

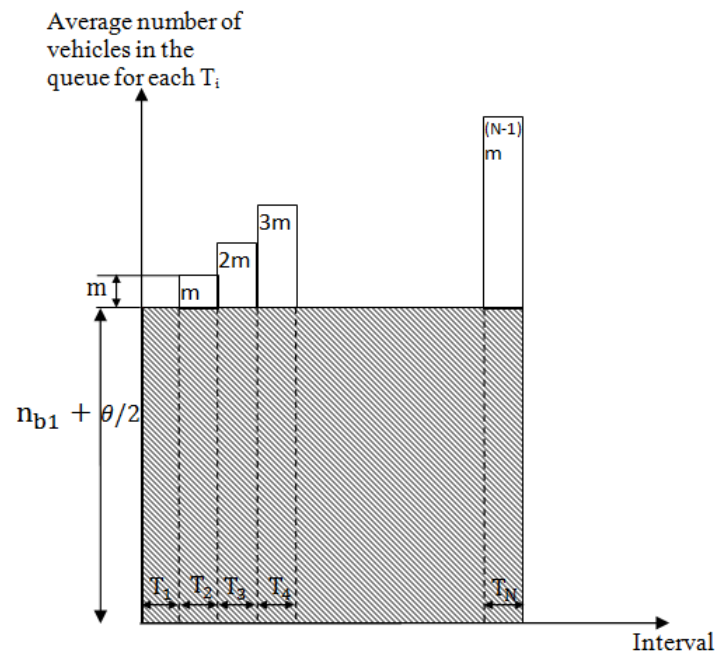

Figure 4-4: Average Number of Vehicles in the Queue for Each T_i

4.3 Discussion

4.3.1 Queue length variation

The problem was solved when groups have interaction and average number of vehicles within 's increases (see

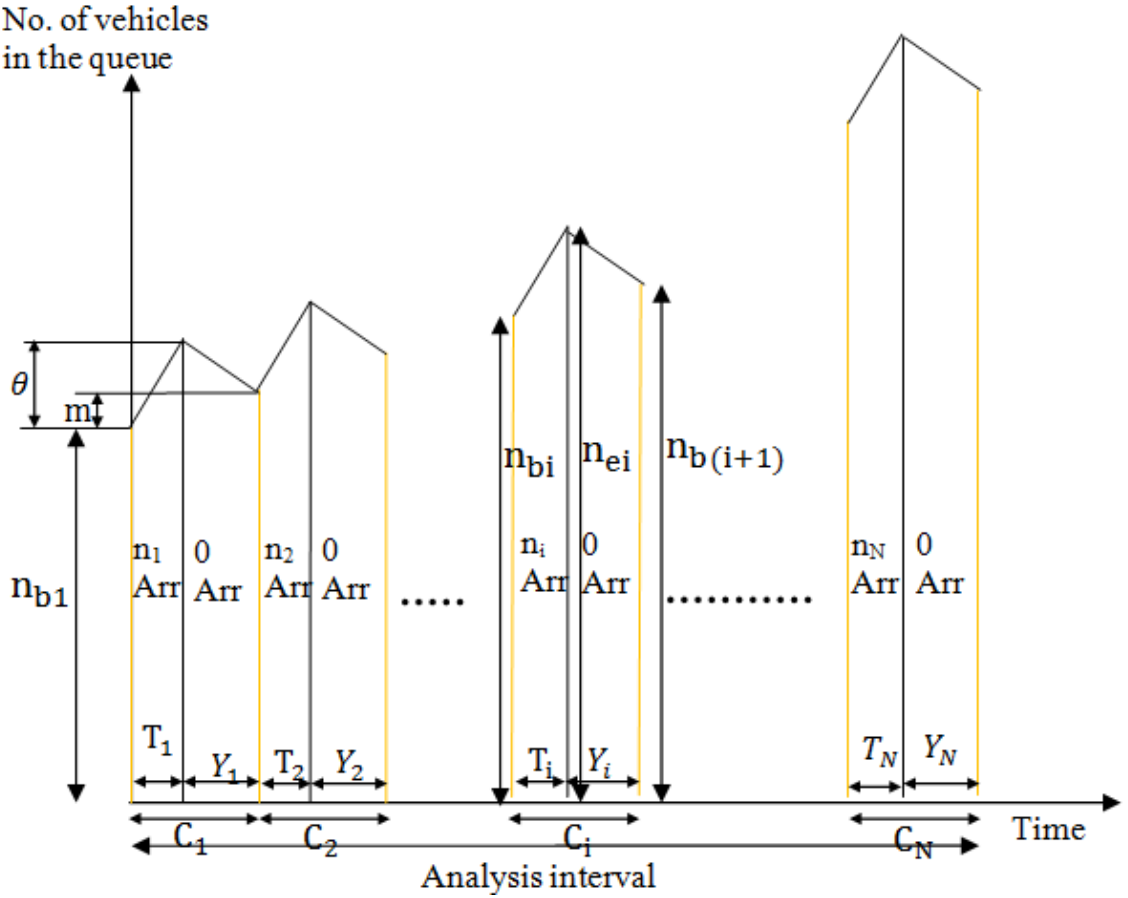

Figure 4-3) however generally the following condition may happen:

- 1) Groups do not have interaction which means that the group i leaves the bottleneck before arriving the group i+1. This case happens if

and

4-19

Where

n =the average group size which is also equal to the arriving volume of each cycle,

θ =The maximum departure rate of each cycle,

=Number of vehicles at the beginning of the analysis interval

2) Groups have interaction

2.1) Average queue length within t 's increases in which case

4-20

2.2) There is an initial queue in the beginning of the analysis interval and the average queue length within t 's decreases. In this case the following condition should be satisfied:

4-21

2.3) There is an initial queue in the beginning of the analysis interval but the average queue length within t 's is constant in which case:

4-22

In order to compute total delay for each case, it suffices to choose the appropriate m as below:

4-23

Where m conceptually represents the accumulation rate of the average number of vehicles in queue over t 's.

4.3.2 Input variables

The input variables of Equation 4-18 are divided into two groups:

- 1) The variables that can be estimated having speed-flow relationship for the work zone. These variables are listed below:
 - 1.1) Average speed in queue, v_q ,
 - 1.2) Adjusted capacity, C_a , and

1.3) Average spacing in the queue, X .

To obtain these values, we recommend using the speed-flow relationships developed by Benekohal et al. (2010) for highway work zones where one of the two lanes is closed due to construction activity. That study covered some of work zones with speed limits of 45 mph and 55 mph, and work zones with flagger and 45 mph speed limit. However, it did not cover all types of work zones. So it is recommended to collect field data for other work zone configurations and for work zones with ITS.

2) The group characteristics:

2.1) Group size, n ,

2.2) Group arrival time,

2.3) Inter-arrival gap for the groups, Y , and

2.4) Total number of groups within a given interval, N .

Field data analysis is recommended to model the effect of volume and percentage of heavy vehicles on the group characteristics.

4.4 Reference

R. Benekohal, H. Ramezani, K. Avrenli, (2010), Delay and User's Cost in Highway Work Zones, Research Report ICT-10-07. Retrieved from <http://ict.illinois.edu/publications/report%20files/FHWA-ICT-10-075.pdf>

CHAPTER 5. QUEUE FORMATION AND DISSIPATION IN WORK ZONES

5.1 Introduction

Knowing queue length and delay at highway bottlenecks is critical in traffic management and design. Results of the queuing analysis are used in deciding the hours of work zone operation (peak, off peak, daytime, night time), selecting detours, making temporary capacity improvements, or providing real-time information to motorists.

Some past studies focused on delay and queue length estimation in work zones. Jiang (1999) and Chitturi et al. (2008) developed models to estimate delay and users' cost in work zones where vehicles are stopped in the queue. Ramezani et al. (2010) proposed a methodology to estimate moving queue length and corresponding delay in work zones. Chitturi and Benekohal (2009) modeled effects of speed distribution and speed difference between cars and trucks on delay estimation. Furthermore, they developed speed-flow curves for uncongested condition using simulation data and proposed a step-by-step methodology to estimate delay.

The above-mentioned studies assumed that there was only one bottleneck location in a work zone that caused the queuing and congestion. The queuing and congestion sometimes started at the transition area (Jiang 1999), or at the work space (Chitturi et al. 2008, Chitturi and Benekohal 2009, Ramezani et al. 2010). We acknowledge that there are two locations in work zones, namely the work space and the transition area, which can be potentially operating as a bottleneck.

This chapter uses shockwave analysis to investigate queue formation and dissipation in work zones where there is one or more bottlenecks. In Section 5.2, the geometry of a typical work zone is explained. Section 5.3 introduces notations. Sections 5.4 and 5.5 explain the mechanism of queue formation and dissipation, respectively. Section 5.6 discusses computational issues for delay and queue length estimations. Conclusions and discussions will be made in Section 0.

5.2 Geometry of a typical 2-1 work zone

This section describes a typical and its simplified version of a 2-to-1 work zone, where one of the two lanes is closed due to construction activities.

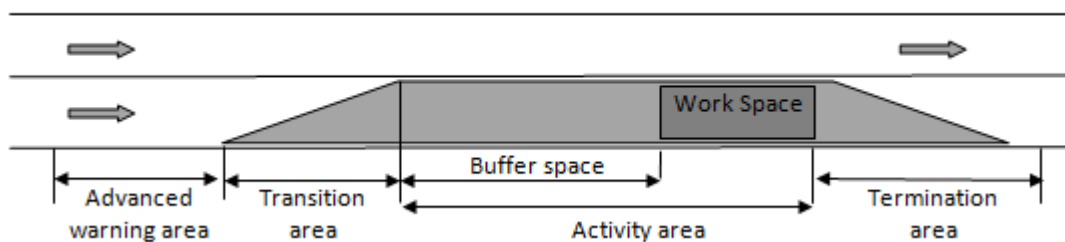

Figure 5-1: The Typical Sketch of 2-to-1 Work Zones

Figure 5-1 shows the typical sketch of a 2-to-1 work zone using the MUTCD definitions. The work zone consists of four areas: advance warning area, transition area, activity area and termination area. Activity area is further divided into buffer space and work space. Traffic moves from the left to the right in Figure 5-1.

As mentioned before, two locations can potentially be operating as a bottleneck: 1) the transition area where the capacity drops due to the lane closure 2) the work space where traffic slows down due to work activities and this speed reduction may cause a capacity drop. There may be many reasons for traffic to slow down near the work space. For instance, drivers may reduce speed to avoid any collision with workers, to respond to a flagger showing “Slow Down” paddle, or in response to other traffic control device.

For the purpose of problem formulation, it is assumed that lane drop happens abruptly at the beginning of the transition area. Figure 5-2 shows the simplified work zone sketch in which point C corresponds to the beginning of the transition area. Section 1 represents the work space, Section 2 shows the space between the beginning of the transition area and beginning of the work space, and Section 3 represents the two-lane section before the transition taper.

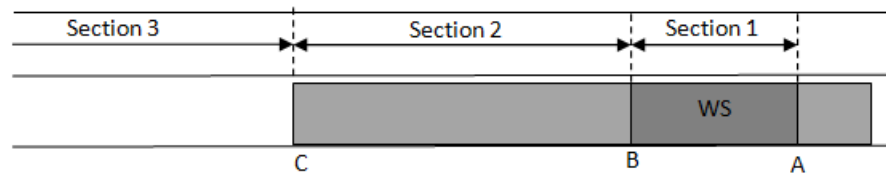

Figure 5-2: Simplified Sketch of a 2-to-1 Work Zone

5.3 Notation

The notations used are defined below.

ρ_i , $\rho_{i,c}$, and $\rho_{i,s}$ = Points representing undersaturated traffic states on the fundamental diagram for Section i of the road.

$\rho_{i,c}$ = Point representing capacity on the fundamental diagram for Section i ,

$\rho_{i,s}$, and $\rho_{i,t}$ = Points representing congested traffic states on the fundamental diagram for Section i .

q_i = The flow rate corresponding to the traffic state ρ_i

ω_i = The shock wave created by the traffic states $\rho_{i,s}$ and $\rho_{i,t}$.

5.4 Queue Formation

Fundamental curves of the following sections of the road are needed for shock wave analysis:

- 1) Work space (between point A and B in Figure 2).
- 2) The one-lane section before work space (between point B and C in Figure 5-2)
- 3) Upstream of the transition area (before point C in Figure 5-2)

Since no work activity exists downstream of point A and also after a while, lane closure is terminated, it is assumed that the capacity of the roadway section downstream of A is higher than the capacity of the work space. Therefore, there is no potential

bottleneck location after the work space and no need for the fundamental curve of this section.

Another assumption is that the capacity of the transition area is higher than the capacity of the work space. Otherwise, the departure volume of the transition area cannot exceed the capacity of the work space, and hence, there is practically just one bottleneck location, i.e. the transition area. In that case, the problem could be reduced to the simple case of a freeway section with a single bottleneck.

It is also assumed that capacity of the road before the transition area is higher than the capacity of the transition area. Thus, the following relationship exists among the capacities of the three sections:

Figure 5-3 shows the general form of the flow-density curves for Sections 1, 2, and 3.

Assume that a traffic wave enters the two-lane section of the work zone. We keep track of the resulting shock waves and traffic state evolution over the work zone. The flow rate of the coming wave, q , will satisfy one of the following conditions:

Case 1 does not create any queuing condition since the flow rate of the incoming wave is less than the capacity of all the bottlenecks. Hence, queue propagation is studied only for Cases 2 and 3.

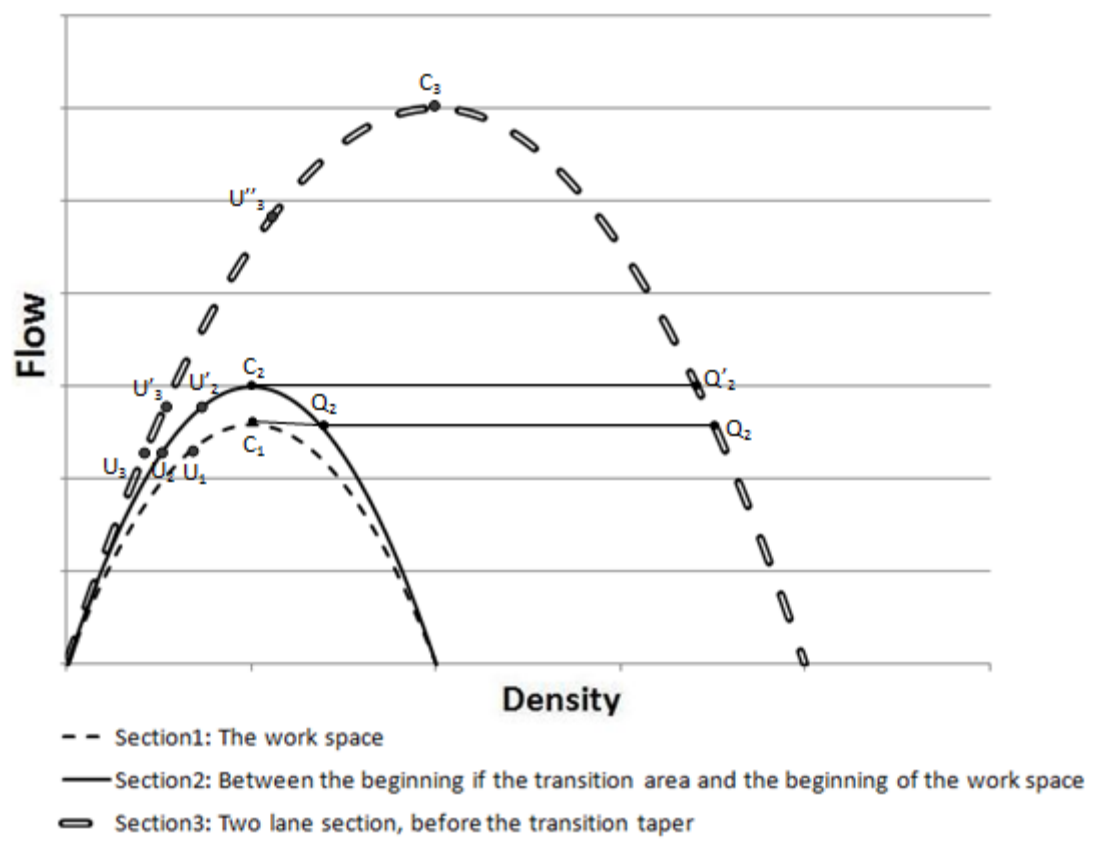

Figure 5-3: The Flow-density Curves of The Three Work Zone sections

5.4.1 **Case 2: Arriving volume is less than the capacity of the transition area but greater than the work space capacity**

In this case, the flow rate of the wave, Q_2 , is higher than C_1 but less than both C_2 and C_3 . Thus, it is expected to have queue in the work space. For the detailed analysis of the queue propagation, we need to know the initial traffic conditions over the work zone as wave enters the work zone. Before introducing the initial conditions, the concept of “active bottleneck” is defined. An active bottleneck is a bottleneck whose discharge rate is not affected by downstream traffic condition (Daganzo 1997). The following initial conditions can cause queue propagation when a high volume wave such as enters the work zone:

2.1) The work zone is in undersaturated condition,

2.2) The work space is the active bottleneck and the back of queue is in the one-lane section,

2.3) The work space is the active bottleneck and the back of queue is in the two-lane section

5.4.1.1 Case 2.1

Assume there are undersaturated conditions of ρ , ρ , and ρ in the work zone. At some time, a traffic wave of ρ with high volume enters the work zone (See Figure 5-4a). The resulting shockwave, ρ moves forward since the imaginary line connecting ρ to ρ in Figure 5-3 has a positive slope.

When ρ reaches the transition area, the two-lane section will be completely under the state of ρ and a stationary shockwave, ρ , occurs at the beginning of transition area. As the state of traffic changes in the transition area, a forward shockwave of ρ is created (See Figure 5-4b). When ρ , reaches the work space, the process of backward queue building up begins since ρ . Then, the backward shockwave of ρ , propagating as shown in Figure 5-4c. Moreover, the stationary shockwave of ρ occurs at the beginning of the work space. The wave ρ is created and the forward shockwave of ρ moves along the work space until it arrives the end of the work space. Beyond the end of the work space, it is assumed that the capacity of the roadway increases and there is no queue to worry about in this study. On the other hand, when the backward shockwave ρ reaches the lane drop location, a stationary shockwave, ρ , is created. Thereafter, the backward shockwave ρ starts propagating through the two-lane section as displayed in Figure 5-4d.

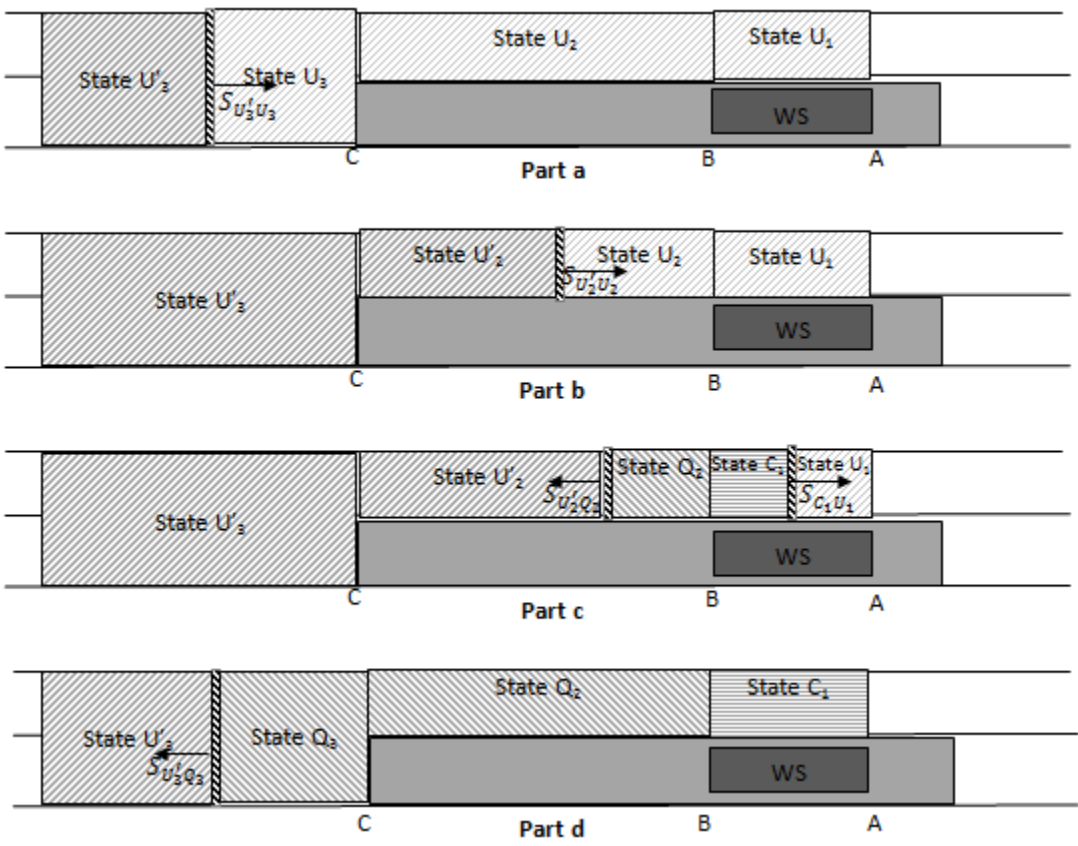

Figure 5-4: Traffic Evolution in The Work Zone for Case2.1

5.4.1.2 Cases 2.2 and 2.3:

Cases 2.2 and 2.3 can be considered as subset of Case 2.1. In Case 2.2, it is assumed that the traffic wave with high volume encounters the back of the queue at the one-lane section. The traffic evolutions for Case 2.2 are those shown in Figure 5-4c –d. Similarly, Case 2.3, in which the back of queue is in two-lane section, is illustrated by Figure 5-4d. So there will be just one backward shockwave, $S_{U_2Q_2}$, and no other moving shockwave will be generated if arriving volume stays at the same level.

5.4.2 Case3: Arriving volume is greater than the capacities of the transition area and the work space

In this case, it is assumed that the volume of the incoming wave is higher than the capacity the transition area.. Like in Case 2, it is needed to consider the initial conditions for queuing analysis. The following initial conditions are considered:

- 3.1) The work zone is in undersaturated conditions,
- 3.2) The work space is the active bottleneck and the back of queue is in the one-lane section,
- 3.3) The work space is the active bottleneck and the back of queue is in the two-lane section,
- 3.4) The transition area is the active bottleneck and the back of the queue is in the two-lane section.

5.4.2.1 Case 3.1

Figure 5-5a illustrates the instant when the high volume wave of ρ_1 enters the work zone with the undersaturated states of ρ_2 , ρ_3 , and ρ_4 . The resulting shockwave of ρ_1 moves forward until it reaches point C.. At this time, one backward shockwave and one stationary shockwave are generated. Since the flow rate of State ρ_1 is higher than the capacity of the transition area, ρ_2 , queue starts propagating backward with a shock wave speed of v_{s1} through the two-lane section. On the other hand, the stationary shock wave of ρ_2 and the wave of ρ_3 are generated as shown in Figure 5-5b. After this instant, the arriving volume of the one-lane section (between B and C) is equal to the departure rate of the transition area. Besides, a shockwave of ρ_3 moves forward (Figure 5-5c) over the one-lane section until it reaches the work space. As shown in Figure 5-3, the flow rate of State ρ_3 is higher than the capacity of the work space, ρ_4 , and another queue will propagate backward (Figure 5-5d).

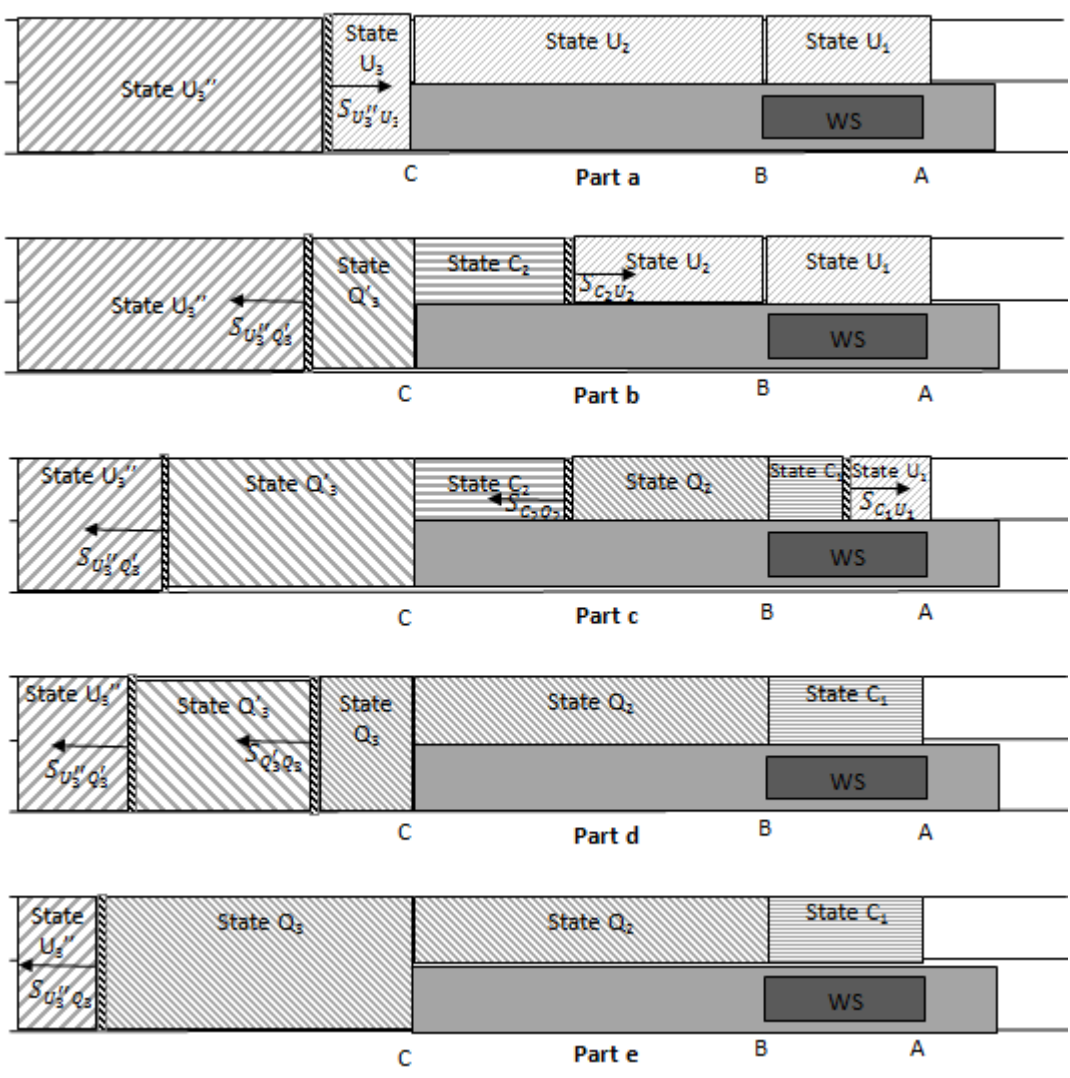

Figure 5-5: Traffic Evolution in The Work Zone for Case3.1

Assuming that the time interval with high demand volume lasts long enough, backward shockwave reaches the beginning of transition area, and then backward shockwave starts moving through the two-lane section (Figure 5-5d).

One can conclude from Figure 5-3 that the speed of is greater than that of . Therefore, these two shock wave meet each other after a while and then remains as the only moving shockwave through the work zone (Figure 5-5e).

5.4.2.2 Case 3.2

In this case, the work space is the active bottleneck and the back of queue is in the one-lane section. Hence, the traffic condition at the upstream of the back of queue should be in undersaturated condition such that the its flow rate is less than the capacity of the transition area, C_2 , but greater than the work space capacity, C_1 . Assume that traffic states at the upstream of the queue are U_2' and U_3' in the one-lane section and two-lane section, respectively. When the forward shockwave of U_2' reaches the transition area, both the backward shockwave of U_3' and the forward shockwave of U_2' start propagating. Figure 5-6b illustrates what happens shortly after these two shockwave were generated. Two separate queuing conditions exist in the work zone: one in the one-lane section and the other in the two-lane section. Forward shockwave U_2' and backward shockwave U_3' move toward each other until they meet and the wave U_2' , diminishes. From that time on, the evolution of traffic will be the same as those shown in Figure 5-5c-e as explained in Case 3.1.

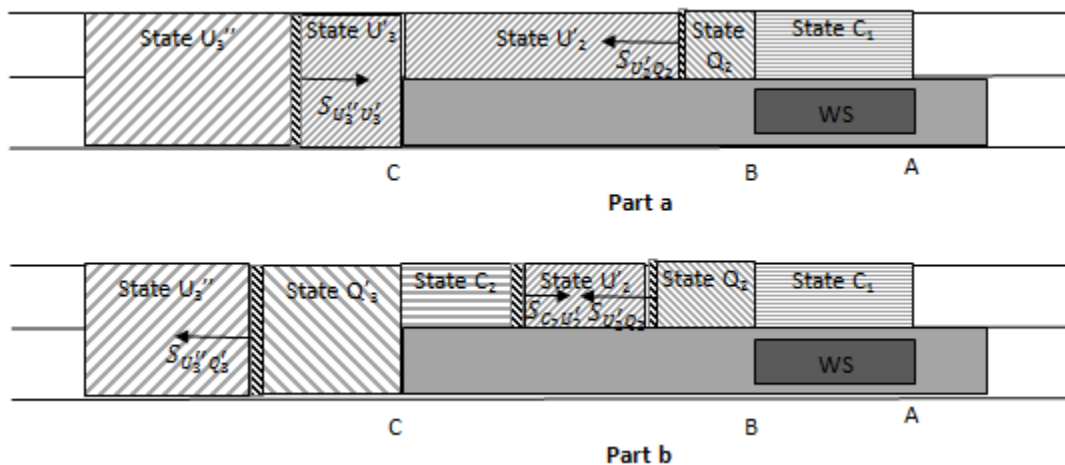

Figure 5-6: Traffic Evolution in The Work Zone for Case 3.2

5.4.2.3 Case 3.3

In this case, the active bottleneck is the work space and the back of queue is in the two-lane section as shown in Figure 5-6e and explained in Case 3.1

5.4.2.4 Case 3.4

In this case, the active bottleneck is the transition area. Hence, this case is the same as the condition displayed in Figure 5-6b and one can follow the rest of the evolution from Case 3.1.

5.5 Queue dissipation

For the recovery condition, it is assumed that a low volume wave, for instance, q_1 , enters the work zone such that

It was shown in the queue propagation discussion that if the time horizon is long enough, the work space will be the only active bottleneck in both Case 2 and Case 3, and the back of queue reaches the two-lane section. Hence, this condition is considered as the initial condition.

Figure 5-7a shows the initial condition in the work zone when the wave of q_1 meets the congested state of q_2 . The resulting forward shockwave, q_3 , moves forward until it reaches the transition area, point C. Then a stationary shockwave of q_4 and a forward shockwave of q_5 are generated (Figure 5-7b). A similar process happens when q_1 reaches the work space. The stationary and forward shockwaves of q_6 and q_7 are generated, respectively (Figure 5-7c). After this time, the work zone is completely in undersaturated condition.

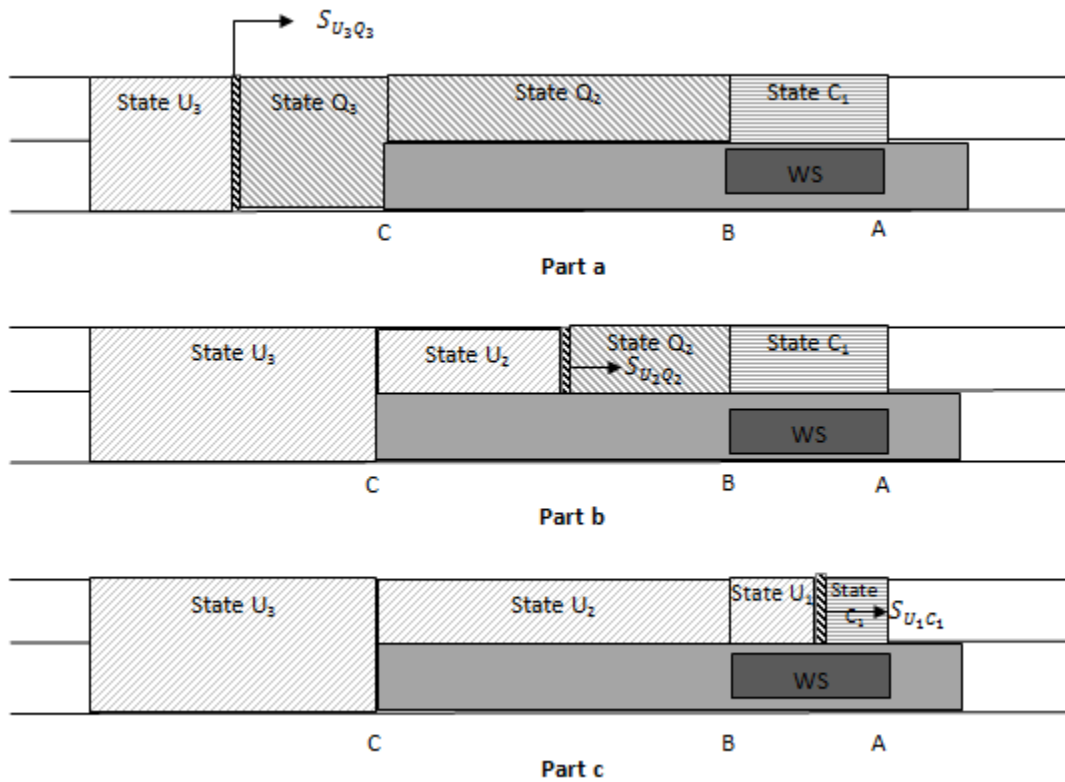

Figure 5-7: Queue Dissipation in The Work Zone

5.6 Delay and queue length computation

The mechanism of queue formation and dissipation was discussed for different cases in Sections 5.4 and 5.5. To compute delay and queue length, spatial and temporal extension of each traffic wave should be determined. Extension of a wave depends on how the boundaries of the wave move.

The boundary between two traffic states is a shockwave and a shockwave has a speed and direction that it moves. The direction of movement and speed of each boundary is the same as the direction of movement and speed of the corresponding shockwave. For example in Figure 5-5d, the front and rear boundaries of C_1 are fixed. Thus, this state does not propagate or vanish over time unless the traffic conditions change. On the other hand, one can notice the State Q_3 in the same figure whose front boundary is fixed but rear boundary moves backward.

The front boundary of a traffic state could be either stationary, moving forward or moving backward. Likewise, there are three cases for the movement direction of the rear boundary. Combination of the possible cases for the rear and front boundaries yields 9 categories. Each category shows the movement direction of the rear and the front boundary of a given traffic state. However all 9 categories may not happen in realistic conditions. Based on the discussion in Sections 5.4 and 5.5, the following categories may happen in the field:

Category 1) Both boundaries move backward (see State Q_1 , in Figure 5-5d)

Category 2) The front boundary is fixed while the rear boundary moves backward (see State Q_2 in Figure 5-4c)

Category 3) The front boundary moves forward while the rear boundary is fixed (see State C_1 in Figure 5-4c)

Category 4) The front and the rear boundaries are fixed (see State C_1 in Figure 5-4d)

It is intended to compute the length of each state and the resulting delay within a given time interval. Each of the above-mentioned Categories is investigated in detail. Based on the investigations, a general formulations for the four categories is presented in Section 5.6.3. The general formulation can be applied to any of the 9 categories.

5.6.1 Length of a traffic state

For all the four categories, the length of State W is computed as:

$$5-1$$

Where,

t =time (hr) elapsed since the beginning of the analysis,

W_t =The length of the State W at time t (mile),

W_0 =Length of State W at the beginning of the analysis interval (mile),

=Shock wave speed corresponding to the front boundary (mph),

=Shock wave speed corresponding to the rear boundary (mph),

If the boundaries are stationary, the u_f and u_r will be zero. u_f and u_r are positive when the corresponding boundaries move in the directions of the traffic. Otherwise, they are negative.

5.6.2 Delay

Detailed explanations to establish models for computing delay are given only for Category 1. For other categories the final form of the delay model is given, since the other categories can be considered as the special case of Category 1.

5.6.2.1 Category 1)

In this category, both boundaries move backward, so both u_f and u_r are negative. First, delay is estimated for an individual vehicle, then the results are generalized for all vehicles arriving within a given time interval.

5.6.2.1.1 Delay for an individual vehicle

For vehicle i , which enters State W at time t_i , the delay is computed as:

5-2

— —

Where

=delay for vehicle i , which enters State W at time t_i ,

=Travel length for vehicle i within State W

=Speed of the traffic under State W ,

= Speed of the traffic under the free flow condition.

Equation 5-2 provides delay values that are positive or zero. For vehicles traveling faster than the free flow speed, the equation yields a zero delay.

The goal is to compute delay as a function of the length of State W, which was computed in Section 5.6.1.

Figure 5-8a shows vehicle i, which enters State W at time t_i . The length of the State at this time is $L(t_i)$. As vehicle i travels through State W, the front boundary of the state moves toward the vehicle. So the travel length of vehicle i () is not equal to $L(t_i)$. Figure 5-8b shows vehicle i, which leaves State W at time $(t_i + TT_i)$, where TT_i is the travel time of vehicle i within State W.

It is intended to find a relationship between $L(t_i)$ and $TL(t_i)$ and estimate delay as a function of $L(t_i)$.

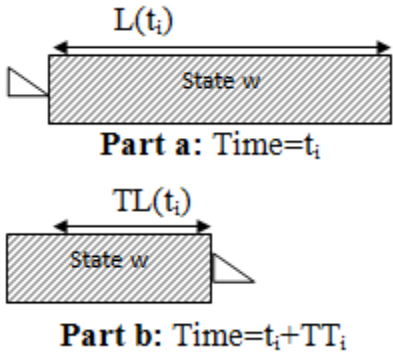

Figure 5-8: Category One

The front boundary and vehicle i are $L(t_i)$ apart from each other at time t_i , and they reach each other after TT_i . Thus:

5-3

Also

5-4

Combining Equations 1-3 and 5-4 5-3:

5-5

Substituting from Equation 5-4 into Equation 5-2, the delay for vehicle i is computed as:

_____ 5-6

5.6.2.1.2 Total Delay:

Total delay, D, is computed using Equation 5-7, assuming that traffic is in queuing conditions:

_____ 5-7

Where

I is the set of all vehicles entering State W within the analysis interval.

is the only term in Equation 5-7 that depends on time. Since the other terms are constant, then:

_____ 5-8

The series in Equation 5-8 can be computed as follow:

5-9

Where

=The average length of State W within the analysis interval,

=Arriving volume during the analysis interval,

Since $L(t)$ is a linear function of time (See Equation 5-1), $L(t_i)$ is a simple average of $L(t_1)$ and $L(t_2)$.

Substituting $L(t_i)$ from Equation 5-9 into Equation 5-8 gives:

$$D = \frac{L(t_1) + L(t_2)}{2} \cdot TT_i \tag{5-10}$$

Defining

$$K = \frac{L(t_1) + L(t_2)}{2} \tag{5-11}$$

Total delay, D , is estimated as:

$$D = K \cdot TT_i \tag{5-12}$$

Equation 5-12 can be used for the other categories as they are some special cases of Category 1. However, the value of K in Equation 5-11 might be different than that of Category 1. Hence, K is computed separately for the other categories.

5.6.2.2 Category 2)

The front boundary is fixed ($\Delta = 0$) while the rear boundary moves backward ($\Delta < 0$). Therefore, K equals one based on Equation 5-11.

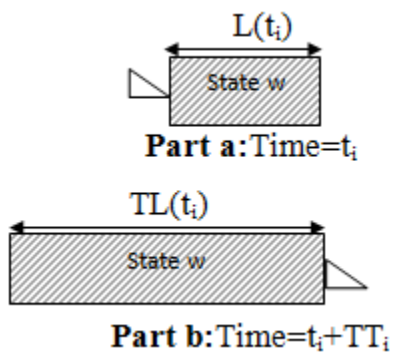

Figure 5-9: Category Two

5.6.2.3 Category 3)

The front boundary moves forward ($\delta > 0$) while the rear boundary is fixed ($\delta = 0$). Thus, Equation 1-11 should be used to estimate K.

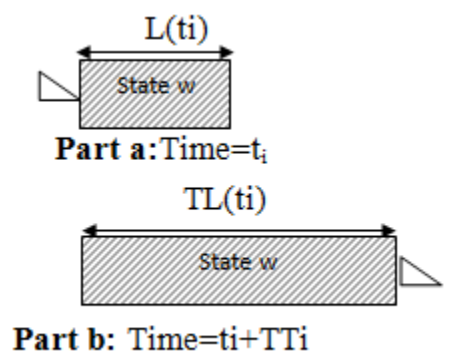

Figure 5-10: Category Three

5.6.2.4 Category 4)

The length of the state is fixed over time. Hence, δ and δ' will be zero and K equals one for this case.

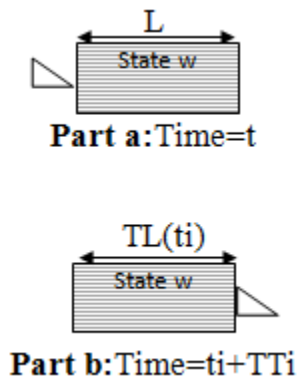

Figure 5-11: Category Four

5.6.3 Summary

In summary, for all the four categories 5.6 , the length of each state is computed as:

Where,

t=Time (hr) elapsed since the beginning of the analysis,

=The length of State W at time t (mile),

=The length of State W at the beginning of the analysis interval (mile),

=The shock wave speed corresponding to the front boundary (mph), such that

=The shock wave speed corresponding to the rear boundary (mph), such that

Total delay in the queuing states is also estimated as follow:

— —

5-14

Where

V= Arriving volume (vph),

=Average length of State W within the analysis interval (mile),

=Speed of the vehicles in State W (mph),

=Free flow speed (mph),

=Computed using Equation 5-15:

5.7 Conclusions and discussions

This section analyzed the mechanism of queue formation and dissipation in work zones as a combination of two bottlenecks: the transition area and the work space. Detailed analysis showed that when the volume exceeds capacity of both the transition area and the work space, there are two separate queues in the work zone. However, if the arriving volume maintains above the capacities during a-long-enough interval, the two queues join each other. After this time, the transition area will be deactivated as a bottleneck and the work space will be the only active bottleneck.

In addition, it was shown that when the arriving volume is less than the capacity of the transition area and greater than the work space capacity, one queue will be formed within the work zone. Under this condition, the work space is the only active bottleneck.

No assumption was made about the general form of the fundamental curves. Nevertheless, the analyses were made particularly for 2-to-1 work zones. One can use the results of this study to estimate delay, queue length, and extension of congestion as well as to detect the location of active bottlenecks in work zones.

5.8 References

Chitturi, M. V.; Benekohal, R. F.; Kaja-Mohideen, A., 2008, Methodology for Computing Delays and Users Costs in Work Zones, Transportation Research Record.

Chitturi, M.V., R.F. Benekohal, 2009. Work Zone Queue Length and Methodology. 89th TRB Annual Meeting CD-ROM.

Jiang, Y, 1999, A Model for Estimating Excess User Costs at Highway Work Zones, Transportation Research Record, No. 1657.

Jiang, Y., 1999, "Traffic Capacity, Speed, and Queue-Discharge Rate of Indiana's Four-Lane Freeway Work Zones", Transportation Research Record 1657.

Daganzo, C., 1997. Fundamentals of Transportation and Traffic Operations. Elsevier, New York.

Ramezani, H.; Benekohal, R. F.; Avrenli, K.; Methodology to Estimate Moving Queue Length and Delay in Highway Bottlenecks. TFT 2010 Conference Proceeding.

CHAPTER 6. CONCLUSIONS

Software programs used to analyze congestion in work zones were presented. Two types of softwares were considered: 1) Analytical softwares such as Quickzone and QUEWZ 2) Micro-simulation softwares such as FRESIM and VISSIM. Analytical softwares do not generally model some of the field conditions like moving queue, presence of flagger and ITS. On the other hand, micro-simulation software programs need more input data and human resources than analytical software programs. Although micro-simulation packages apply some behavioral rules to simulate drivers' reactions and vehicles motion, the behavior of drivers in work zones is not well known.

Next, the effects of large gaps on capacity measurement were investigated. Usually, maximum 15-minute flow rate is used to measure capacity. Data analysis showed that pre-breakdown and post-break down capacity may be underestimated due to the presence of large gaps. On the other hand, presence of large gaps does not have substantial effect on measuring breakdown capacity. Alternatively, a new method to estimate work zone capacity was recommended. First, potential capacity defined as the reciprocal of the average headway for vehicles in medium and large platoons is estimated. Then, the potential capacity is multiplied by platooning factor to yield work zone capacity. The platooning factor takes into account the effect of inter-platoon gaps (large headways) on the capacity estimations.

Moreover, two types of moving queue were studied: 1) intermittent moving queue, and 2) continuous moving queue. A methodology to estimate intermittent queue length and delay was developed. It is able to estimate delay and queue length that last for a portion of the analysis interval or longer. It is also capable of estimating queue length

and delay under both uniform and non-uniform arrival pattern. Continuous moving queue propagation and dissipation were investigated using shockwave theory. The following three locations were considered as the potential bottlenecks in work zones: 1) the work space, 2) the beginning of the transition area, 3) both locations. The interactions among the shockwaves caused by the bottleneck locations were investigated. Formulations were developed to estimate continuous moving queue length and the resulting delay for each case.

The following recommendations are made for future study and applications:

- 1) Developing a software program capable of analyzing intermittent and continuous moving queues in work zones.
- 2) Data collection and capacity measurement for varying work zone conditions (like presence of ITS and different geometric conditions) that were not covered in the existing analytical software programs.
- 3) Collection of further field data is recommended to explore whether post-break down and pre-break down capacities are practically different for a given site.